

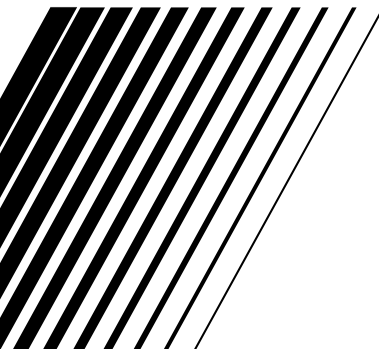

HDD RECORDER/DVD PLAYER

XV-DDV1SL

TV tuner is built in this product.

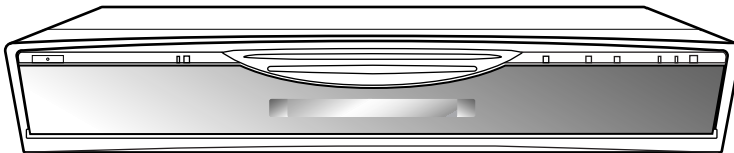

INSTRUCTIONS

Parts Identification	6	
Remote Control Settings	9	
Installing the Unit	11	
Initial Settings	13	
HDD	Watching TV	21
	HDD Recording/Playback	23
	Editing HDD Navigation	34
	Timer Recording	40
DVD	Basic DVD Operations	47
	Advanced DVD Operations	51
	MP3/JPEG Operations	61
Changing the Initial Settings	66	
External Component Operations	82	
Additional Information	88	

IMPORTANT for the U.K.

DO NOT cut off the mains plug from this equipment. If the plug fitted is not suitable for the power points in your home or the cable is too short to reach a power point, then obtain an appropriate safety approved extension lead or consult your dealer.

BE SURE to replace the fuse only with an identical approved type, as originally fitted.

If nonetheless the mains plug is cut off ensure to remove the fuse and dispose of the plug immediately, to avoid a possible shock hazard by inadvertent connection to the mains supply.

If this product is not supplied fitted with a mains plug then follow the instructions given below:

IMPORTANT.

DO NOT make any connection to the terminal which is marked with the letter E or by the safety earth symbol or coloured green or green-and-yellow.

The wires in the mains lead on this product are coloured in accordance with the following code:

Blue: Neutral
Brown: Live

As these colours may not correspond with the coloured markings identifying the terminals in your plug proceed as follows:

The wire which is coloured blue must be connected to the terminal which is marked with the letter N or coloured black.

The wire which is coloured brown must be connected to the terminal which is marked with the letter L or coloured red.

IF IN DOUBT - CONSULT A COMPETENT ELECTRICIAN.

CAUTION

To reduce the risk of electrical shocks, fire, etc.:

1. Do not remove screws, covers or cabinet.
2. Do not expose this appliance to rain or moisture.

Caution — \odot /I STANDBY/ON button!

Disconnect the mains plug to shut the power off completely.

The \odot /I STANDBY/ON button in any position does not disconnect the mains line.

The power can be remote controlled.

Cautions:

- Do not block the ventilation openings or holes. (If the ventilation openings or holes are blocked by a newspaper or cloth, etc., the heat may not be able to get out.)
- Do not place any naked flame sources, such as lighted candles, on the apparatus.
- When discarding batteries, environmental problems must be considered and local rules or laws governing the disposal of these batteries must be followed strictly.
- Do not expose this apparatus to rain, moisture, dripping or splashing and that no objects filled with liquids, such as vases, shall be placed on the apparatus.

Caution: Proper Ventilation

To avoid risk of electric shock and fire and to protect from damage.

Locate the apparatus as follows:

- Front: No obstructions and open spacing.
Sides: No obstructions in 3 cm from the sides.
Top: No obstructions in 5 cm from the top.
Back: No obstructions in 15 cm from the back
Bottom: No obstructions, place on the level surface.

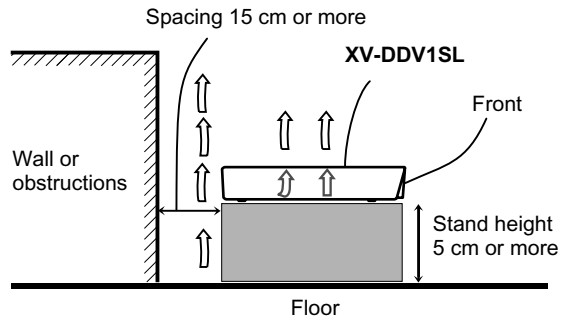
**IMPORTANT FOR LASER PRODUCTS**

1. CLASS 1 LASER PRODUCT
2. **CAUTION:** Do not open the top cover. There are no user serviceable parts inside the unit; leave all servicing to qualified service personnel.
3. **CAUTION:** Visible and invisible laser radiation when open and interlock failed or defeated. Avoid direct exposure to beam.
4. REPRODUCTION OF LABEL: CAUTION LABEL, PLACED INSIDE THE UNIT.

CAUTION: Visible and invisible laser radiation when open and interlock failed or defeated. AVOID DIRECT EXPOSURE TO BEAM.	ADVARSEL: Synlig og usynlig laserstråling når maskinen er åben eller interlocken fejler. Undgå direkte eksponering til strålingen.	VARNING: Synlig och osynlig laserstråling när den öppnas och spärren är urkopplad. Beträkta ej strålen.	VARO: Avlåtessa ja suojalukitus ohitettuna tai viallisena olet alitina näkyvälle ja näkymättömälle lasersäteilylle. Vältä säteen kohdistumista suoraan itseesi. (f)
(e)	(e)	(d)	(s)

IMPORTANT

It should be noted that it may be unlawful to re-ordered pre-recorded tapes, records, or discs without the consent of the owner of copyright in the sound or video recording, broadcast or cable programme and in any literary, dramatic, musical, or artistic work embodied therein.

Check the copyright laws in your country before recording from DVD Video, SVCD, Video CD, Audio CD, MP3 and JPEG discs. Recording of copyrighted material may infringe copyright laws.

- You cannot record from the built-in DVD player onto the HDD.

ATTENTIONS:

- Using a cellular phone nearby the unit may cause picture disturbance on the TV. (In the worst case, nothing but a blue back screen appears on the TV.)
- Some TVs or other appliances generate strong magnetic fields. Do not place such appliance on the unit as it may cause picture disturbance.

Failure to heed the following precautions may result in damage to the discs, the built-in hard disc drive (HDD), and the remote control.

1. DO NOT place the equipment...

- in an environment prone to extreme temperatures or humidity. (Select a place which is level, dry and neither too hot nor too cold between 5°C and 35°C.)
- in direct sunlight.
- in a dusty environment.
- in an environment where strong magnetic fields are generated.
- on a surface that is unstable or subject to vibration.

2. DO NOT block the cooling fan.

If the cooling fan is blocked by a newspaper or cloth, etc., the internal heat buildup may cause fire.

- The cooling fan starts rotating when the internal heat builds up (and may keep rotating until the safe inside temperature is obtained even after you turn off the power).

3. DO NOT place heavy objects on the equipment.

4. DO NOT place anything which might spill on the equipment.

If water or liquid is allowed to enter the equipment, fire or electric shock may be caused.

5. DO NOT expose the equipment to dripping or splashing.

6. DO NOT use the equipment in a bathroom or a wet place.

7. DO NOT place any containers filled with water or liquids (such as cosmetics or medicines, flower vases, potted plants, cups, etc.) on the equipment.

8. DO NOT place any naked flame sources, such as lighted candles, on the equipment.

9. DO NOT impart violent shock to the equipment during transport.

Moisture condensation

Moisture in the air will condense inside the unit when you move it from a cold place to a warm place, or under extremely humid conditions—just as water droplets form in the surface of a glass filled with cold liquid. In conditions where condensation may occur, keep the unit turned on for a few hours to let the moisture dry.

Notes on the power cord

- When you are away on travel or otherwise for an extended period of time, remove the plug from the wall outlet. A certain amount of power (15 W) is always consumed while the power cord is connected to the wall outlet.
- When unplugging the unit from the wall outlet, always pull the plug, not the power cord.
- Do not handle the power cord with wet hands

Precautions for the HDD

1. Before using the unit:

When the power is on, the HDD is constantly rotating at a high speed.

This requires you to note the following:

- DO NOT impart vibration or shock. If given a heavy shock, not only is the data recorded damaged but also the HDD itself is damaged.
- DO NOT allow anything having strong magnetism or emitting strong electromagnetic waves (cellular phones, etc.) near the unit.
- DO NOT disconnect the power plug from the wall outlet when the power is on. If the power supply is cut off while the HDD is in operation, it can be damaged or the stored data may be damaged. Be sure to press the  (STANDBY/ON) button to turn off the power.

2. While using the unit:

- When viewing a TV program through the built-in tuner, you might notice a slight time lag compared to the actual program being broadcast. This happens because pictures received are once stored in the HDD, and then played back. The time lag is approximately 3 seconds.
- If you turn the power on with the HDD already selected, it will take about 20 seconds before the received pictures appear on the TV. During this period, no operation is accepted.
- The HDD may produce mechanical noise while power is on, but it is not a malfunction.

This product incorporates copyright protection technology that is protected by method claims of certain U.S. patents and other intellectual property rights owned by Macrovision Corporation and other rights owners. Use of this copyright protection technology must be authorized by Macrovision Corporation, and is intended for home and other limited viewing uses only unless otherwise authorized by Macrovision Corporation. Reverse engineering or disassembly is prohibited.

VIDEO Plus+[®]
DELUXE

VIDEO Plus+ and PlusCode are registered trademarks of Gemstar Development Corporation. The VIDEO Plus+ system is manufactured under license from Gemstar Development Corporation.

Precautions on the built-in DVD player

Playable disc types

Discs with the following marks can be played back on the unit.

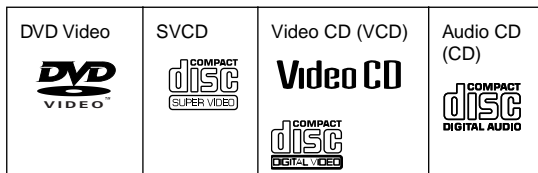

The DVD Logo is a trademark.

The unit can also play back the following discs:

- DVD-R and DVD-RW discs written in the DVD Video format and finalized.
- CD-R and CD-RW discs written in the SVCD, Video CD or Audio CD format and finalized.
- CD-R and CD-RW discs written in MP3 (see page 61) in accordance with the "ISO 9660" format.
- CD-R and CD-RW discs written in JPEG (see page 63) in accordance with the "ISO 9660" format.

NOTE

This unit may need considerable time to read the contents of the disc, or the unit may not be able to play back a disc if it is dirty, scratched or warped.

- The disc characteristic or recording condition may also affect reproduction of the disc itself.

The unit can play back audio signals recorded in Mix-Mode CD, CD-G, CD-Extra and CD Text.

Region code of DVD Video

This unit can play back DVD Video discs whose region code numbers include "2."

Examples:



Colour system format

This unit accommodates the PAL system, and also can play back discs recorded with NTSC system whose Region Code numbers include "2."

- NTSC video signals are converted to PAL signals and reproduced. (It may deteriorate picture quality slightly.)

NOTES

- With some DVD Video discs, the unit starts playback automatically after inserting the disc.
- The image may be sometimes poor or noisy due to defects in the disc itself.
- With some discs, operations described in this manual may not be accepted.

Unplayable discs

The unit does not play back discs listed below. If you try to play back these discs, noise may generate causing damage to the speakers.

- DVD-RW discs written in the VR format
- DVD-ROM, DVD-RAM, DVD Audio, CD-ROM, Photo CD, SACD

In addition, the unit does not play:

- Unfinalized discs
- Discs of irregular shape or discs with tape, seals or paste on either the label side or playback side. Playing back these discs may damage the unit.

Digital audio formats

The unit supports the following digital audio formats—Linear PCM, MPEG Multichannel, Dolby Digital*, DTS** (Digital Theater Systems) (see page 93 "Glossary" for descriptions of each audio format):

NOTE

Depending on the "DIGITAL AUDIO OUTPUT" setting, digital audio signals may not be output as they are recorded on the disc. See "DIGITAL AUDIO OUTPUT" on page 78 for details.

Care and handling of discs

If a disc gets dirty, dusty, scratched or warped, playback sound and picture may be deteriorated. Take proper precautions when handling discs.

Handling

- Do not touch the surface of the disc.
- Do not damage, stick paper to, or use any adhesive either on the label side or on the playback side.

Storing discs

- Keep discs in their cases. If discs are piled without their protective cases, they may be damaged.
- Do not put discs in a location where they may be exposed to direct sunlight, or where the humidity or temperature is high. Avoid leaving discs in a car!

Cleaning discs

- Wipe with a soft dry cloth, moving from the centre outwards. If a disc is difficult to clean, wipe with a cloth moistened with water.



- Never use record cleaners, petrol, alcohol or any anti-static agents.

* Manufactured under licence from Dolby Laboratories. "Dolby" and the double-D symbol are trademarks of Dolby Laboratories.
** "DTS" and "DTS Digital Out" are trademarks of Digital Theater Systems, inc.

PARTS IDENTIFICATION	6	ADVANCED DVD OPERATIONS	51
Front view	6	Playing from a specific point	51
Rear view	7	• Locating a desired scene (item) from the disc menu	51
Display window	7	• Specifying a desired title.....	52
Remote control	8	• Locating a desired position in the current title or track—Time Search	52
REMOTE CONTROL SETTINGS	9	Changing the playback order	53
Using the remote control.....	9	• Playing in a specific order—Program Play	53
INSTALLING THE UNIT	11	• Playing at random—Random Play	54
Basic connections	11	• Playing repeatedly—Repeat Play	54
INITIAL SETTINGS	13	Changing the language, sound and scene angle	55
Easy & simple setup.....	13	• Selecting the subtitle language.....	56
• Presetting the built-in TV tuner automatically— Auto Setup	13	• Changing the audio language or sound.....	56
• Downloading the preset information from your TV—TV-linked Setup	14	Using sound effects and special picture playback ..	57
Selecting the playback source	16	• Simulating surround sound (3D PHONIC)	57
Setting the satellite controller	17	• Adjusting the picture	58
DVD Initial Setup.....	20	• Zooming in	58
WATCHING TV	21	Menu bar operations	59
Watching TV programmes.....	21	MP3/JPEG OPERATIONS	61
• Receiving stereo and bilingual programmes	22	Playing an MP3 disc	61
HDD RECORDING/PLAYBACK	23	Playing a JPEG disc.....	63
Basic recording	23	CHANGING THE INITIAL SETTINGS	66
• Instant Timer Recording (ITR)	24	Changing the HDD/TV tuner settings.....	66
Basic playback	25	Changing the DVD settings.....	75
Special effect playback.....	26	Limiting playback by children	80
Playing with HDD Navigation.....	29	EXTERNAL COMPONENT OPERATIONS	82
• Selecting programmes on the NAVIGATION screen	30	Setting the remote control code	82
EDITING HDD NAVIGATION	34	Editing from a camcorder	83
Editing HDD Navigation	34	Editing to or from a VCR.....	84
• Modifying recorded programmes	34	Connecting to a satellite receiver.....	86
• Making play lists	37	Connecting to a stereo system	87
TIMER RECORDING	40	ADDITIONAL INFORMATION	88
VIDEO PLUS+® Timer programming	40	Troubleshooting	88
Express Timer programming	42	• On-screen messages	89
• Modifying timer programmings	45	Country/Area code list for Parental Lock.....	91
Automatic Satellite Recording	46	Table of languages and their abbreviations	92
BASIC DVD OPERATIONS	47	Digital output signal chart	92
Playing back discs	47	Glossary	93
• Resuming playback	49	Specifications	94
• Various speed playback	49	Index.....	95
• Locating the beginning of a scene or song.....	50		

Front view

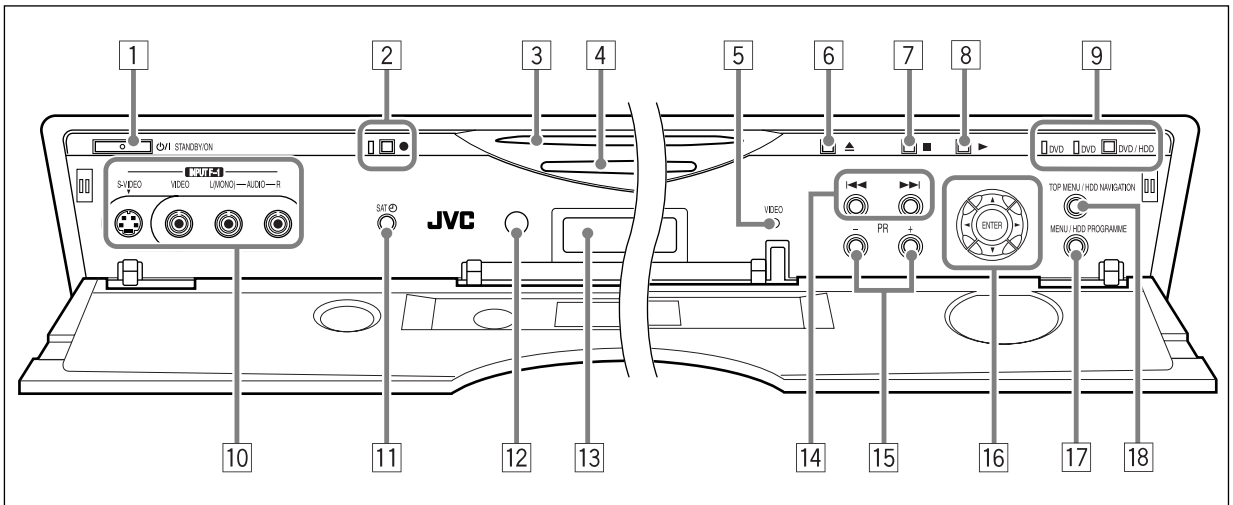

Refer to the page indicated in parenthesis.

- 1 STANDBY/ON button
- 2 (record) button and lamp (22 – 24)
- 3 Illumination lamp
 - Lights when the unit is turned on.
 - Flashes after plugging in the unit (no operations are accepted during this period).
- 4 Disc loading slot
- 5 VIDEO lamp (86)
- 6 (eject) button (48)
- 7 (stop) button (24, 25, 48)
- 8 (play) button (25, 47)
- 9 DVD/HDD button and (DVD and HDD) lamps (19)
- 10 INPUT F-1 connectors (83)
- 11 SAT (timer) button and lamp (46)
- 12 Remote sensor (9)
- 13 Display window

Shows the clock time (or “-- : --”) while the unit is turned off.
- 14 (reverse/forward search) buttons (26, 27, 29, 49, 50)
- 15 PR (programme) + / – buttons (21, 23)
- 16 Menu operation buttons
 - ENTER and cursor (, , ,) buttons
- 17 MENU button (48, 51)
- 18 TOP MENU button (48, 51)
- HDD NAVIGATION button (29 – 33)

How to open and close the front panel

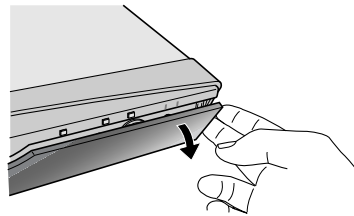

To open, pull the top right edge of the front panel slowly toward you.

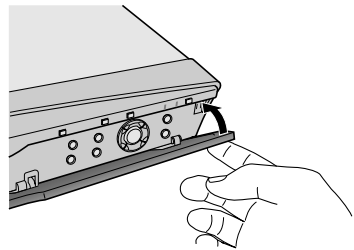

To close, push up the front panel softly.

IMPORTANT

When the unit is turned off, the clock time appears in the main display.

- If the built-in clock has not been set, or lost its setting, “-- : --” appears instead.

Rear view

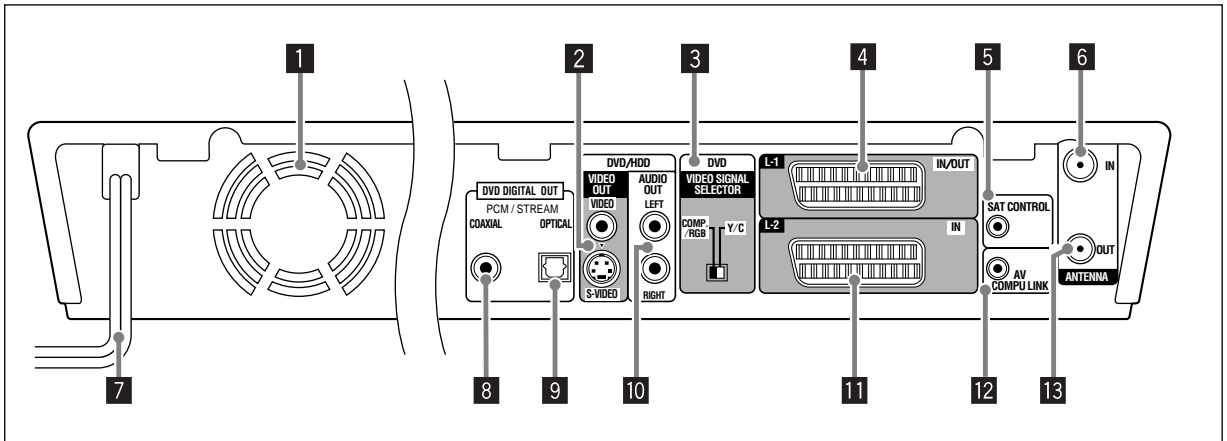

- | | |
|---|---|
| <ul style="list-style-type: none"> 1 Cooling fan 2 DVD/HDD VIDEO OUT connectors (12) <ul style="list-style-type: none"> • VIDEO and S-VIDEO jacks 3 DVD VIDEO SIGNAL SELECTOR (11) 4 L-1 IN/OUT connector (11, 84, 85) 5 SAT CONTROL jack (17) 6 ANTENNA IN connector (11, 12, 86) 7 AC power cord | <ul style="list-style-type: none"> 8 DVD DIGITAL OUT (COAXIAL) connector (87) 9 DVD DIGITAL OUT (OPTICAL) connector (87) 10 DVD/HDD AUDIO OUT connectors (12, 87) <ul style="list-style-type: none"> • LEFT and RIGHT jacks 11 L-2 IN connector (85, 86) 12 AV COMPULINK jack <ul style="list-style-type: none"> • Only for the future use. 13 ANTENNA OUT connector (11, 12, 86) |
|---|---|

Display window

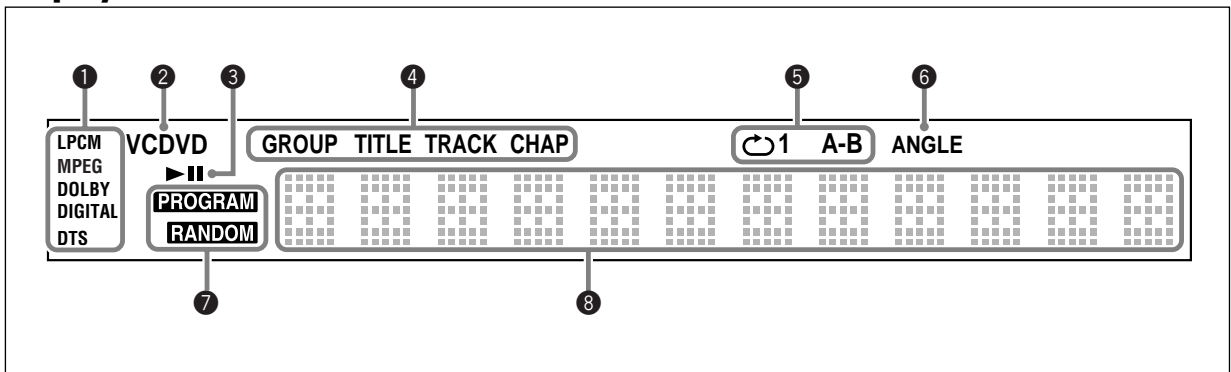

- 1 Digital disc audio format indicators (47)
 - LPCM, MPEG, DOLBY DIGITAL, and DTS
- 2 Disc type indicators (47)
 - DVD, VCD, and CD
- 3 Play/Pause indicator
- 4 Disc segment indicator
 - GROUP, TITLE, TRACK, and CHAP (chapter)
- 5 Repeat indicators (54, 63, 65)
 - Repeat, Repeat 1, and A-B
- 6 ANGLE indicator (56)
- 7 Disc play mode indicators (53, 54)
 - PROGRAM and RANDOM
- 8 Main display
 - When the unit is turned off (on standby), the clock time appears.

Adjusting the brightness of the display window and of the illumination lamp

You can adjust the brightness in the following cases:

- While watching the currently broadcast TV programme, or
- While the DVD player is selected for the playback source, but is not playing (or with no disc loaded).

Press **II while holding **▲** or **▼** (cursor buttons) on the remote control.**

Each time you press **II**, the brightness changes in three levels.

Remote control

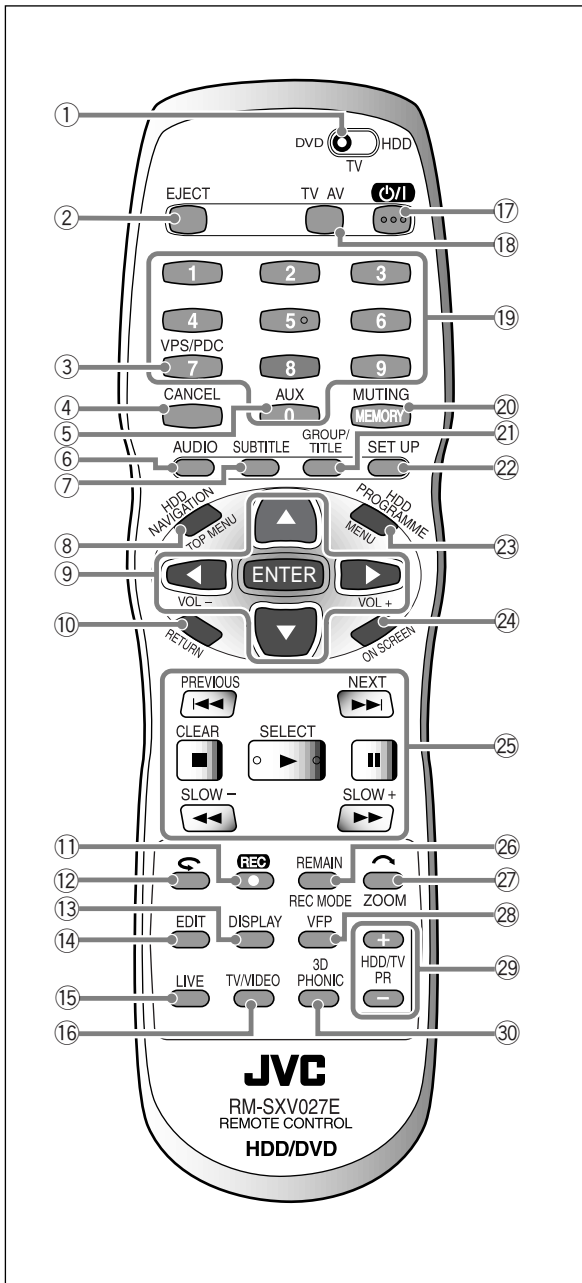

- ① DVD/TV/HDD operation mode selector
- ② EJECT button (48)
- ③ VPS/PDC button (41, 43)
 - This button only works as the PDC (Program Delivery Control) button, but cannot work as the VPS (Video Programme System) button.
- ④ CANCEL button (53)
- ⑤ AUX button (21, 23)
- ⑥ AUDIO button (22, 56)
- ⑦ SUBTITLE button (56)
- ⑧ HDD NAVIGATION button (29 – 33)
TOP MENU button (48, 51)
- ⑨ Menu operation buttons
 - ENTER and cursor (◀/▶/▲/▼) buttons
 - VOL (volume) +/-
 - ◀/▶ buttons can also work for TV volume adjustment when no menu is shown on the TV.
- ⑩ RETURN button (30, 34, 40, 42, 51)
- ⑪ REC ● button (22, 23)
- ⑫ ⏮ (Quick & Short Review) button (22, 50)
- ⑬ DISPLAY button (22)
- ⑭ EDIT button (34 – 39)
- ⑮ LIVE button (21 – 23)
- ⑯ TV/VIDEO button (24)
- ⑰ ⏻ (standby/on) button
- ⑱ TV AV button (9, 10)
- ⑲ Number buttons (21, 23, 50)
- ⑳ MUTING button (10)
MEMORY button (31)
- ㉑ GROUP/TITLE button (52, 62, 65)
- ㉒ SET UP button (66, 75)
- ㉓ HDD PROGRAMME button (40 – 42, 45)
MENU button (48, 51)
- ㉔ ON SCREEN button (28, 48, 52, 59, 63, 65)
- ㉕ DVD/HDD operation buttons
- ㉖ REMAIN/REC MODE button (24)
- ㉗ ⏭ (Quick Skip) button (26)
ZOOM button (58, 65)
- ㉘ VFP (Video Fine Processor) button (58)
- ㉙ HDD/TV PR (programme) + / - buttons (21, 23)
- ㉚ 3D PHONIC button (57)

Using the remote control

Installing batteries

Open the compartment cover, and place the two supplied R6P (SUM-3)/AA(15F) batteries in the remote control according to the polarity markings (“+” and “-”) inside the compartment. Then replace the cover.

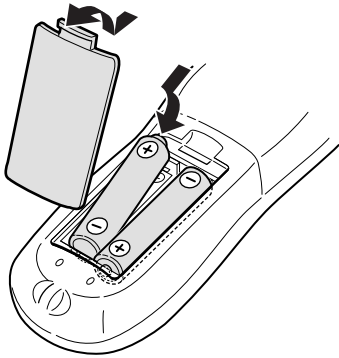

The batteries will last about 6 months with normal use. If the remote control functions erratically, replace the batteries.

Precautions for the safe use of batteries

If the batteries are used improperly, their lives may be shortened, they may burst or their contents may leak. Observe the following precautions carefully.

- Remove the batteries from the remote control if it is not going to be used for a long period of time.
- Never leave used-up batteries lying around, disassemble them, mix them with other refuse, or throw them into an incinerator.
- Never touch liquid if it has leaked out of a battery.
- Do not mix new and old batteries, or batteries of different types, when replacing them.
- Remove used-up batteries and dispose of them properly.

When the discarding batteries, environmental problems must be considered and the local rules or laws governing the disposal of the used-up batteries must be followed strictly.

Remote sensor

Point the top of the remote control toward the remote sensor as directly as possible. If you operate it from a diagonal position, the operating range (approx. 5 m) may become shorter.

Controlling the TV using remote control

Your remote control can operate the basic functions of your TV. In addition to JVC products, other manufacturer’s equipment can also be controlled.

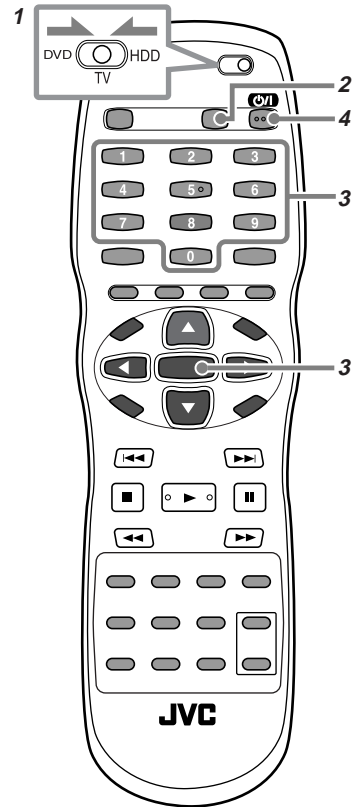

To set the TV’s brand code.

1. Slide the DVD/TV/HDD selector to the centre position (TV).
2. Press and hold TV AV until the setting is over.
3. Press number buttons to enter the brand code, then press ENTER.
 - See the brand code table on page 10.
4. Release TV AV.
5. To confirm whether the setting is correctly done or not, press repeatedly.
 - If the equipment turns on and off, the setting is done correctly.
 - If the equipment does not turn on and off with one code, try entering another.

NOTES

- Once you have set the remote control to operate your equipment, you do not have to repeat this step until you replace the batteries from the remote control.
- You can also change the remote control code for operating JVC video products. See page 82 for details.

Usable buttons for operating the TV

When the **DVD/TV/HDD** selector is set to the centre (**TV**), you can use the following buttons:

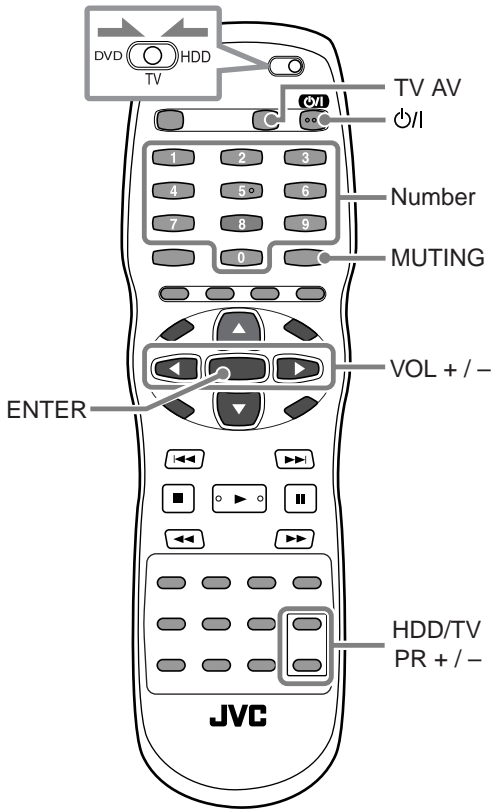

TVs	Codes
JVC	01, 23, 24, 25
AIWA	36
BEIJING	22
CCE	02
CHANGHONG	34
DAEWOO	17, 37
FERGUSON	27
FINLUX	30
FUNAI	32
GRANDIENTE	15, 20
GRUNDIG	19
HITACHI	10
ITT	28
JINXING	38
KONKA	40
LG (GOLDSTAR)	18
MAGNAVOX	02
MITSUBISHI	03
MIVAR	29
NEC	20
NOBLEX	22
NOKIA	31
PANASONIC	04, 11
PEONY	34, 38, 39
PHILCO	10, 17, 21
PHILIPS	02
RCA	05
SAMSUNG	12, 33, 34, 35
SANYO	13, 16
SEARS	13
SHARP	06
SONY	07
TCL	41
THOMSON	26
TOSHIBA	08, 14
ZENITH	09

- TV AV:** Selects the input (AV) mode.
- ⏻/⏻ (standby/on):** Turns on or off the power.
- Number buttons:** Selects the programme position numbers. (For some TVs, press **ENTER** after pressing the **number** buttons.)
- MUTING:** Turns on or off sound muting.
- VOL +/-:** Adjusts the volume.
- HDD/TV PR +/-:** Changes the programme position numbers.

IMPORTANT

Although the supplied remote control is compatible with JVC products, as well as many other models, it may not work with your equipment, or in some instances, may have limited function capability.

Basic connections

Before using the unit, connect the unit to a TV.

Precautions for connections

- Do not connect the AC power cord until all connections are complete.
- Do not connect a VCR in between this unit and TV; otherwise, picture will be distorted while playing back a copy-protected disc. This problem also occurs when connecting the unit to an integrated TV/Video system.

Connecting a TV with the SCART connector

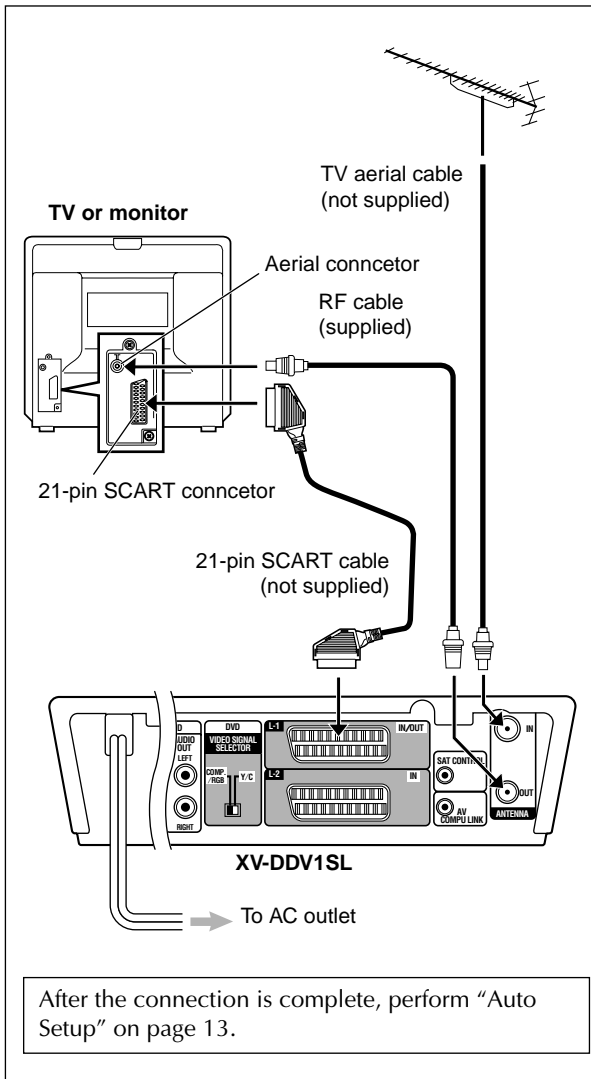

- 1 **Disconnect the TV aerial cable from the TV.**
- 2 **Connect the TV aerial cable to the ANTENNA IN connector on the rear.**

- 3 **Connect the RF cable (supplied) between the ANTENNA OUT connector on the rear and the TV's aerial connector.**
- 4 **Connect the 21-pin SCART cable (not supplied) between the L-1 IN/OUT connector on the rear and the TV's 21-pin SCART connector (input).**

NOTE

For better sound reproduction, it is recommended to connect this unit to an audio amplifier (see page 87).

- 5 **Set the DVD VIDEO SIGNAL SELECTOR properly according to your TV.**

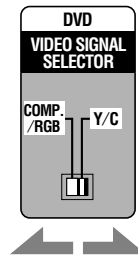

- If your TV only accommodates the composite video signal, set the selector to "COMP./RGB."
- If your TV accommodates Y/C signals, set the selector to "Y/C."
- If your TV accommodates RGB signals, set the selector to "COMP./RGB."

Notice that the HDD deck is not compatible with RGB signals. If you select "RGB" input on your TV, you can view the DVD playback, but may not be able to view the HDD playback.

NOTES

- This selector only works for the output signals through the built-in DVD player. For setting the HDD output/input signals, see "Changing the HDD/TV tuner settings" on pages 66 and 68.
- This selector setting is valid for both the L-1 IN/OUT and L-2 IN connectors on the rear.

- 6 **Plug in the unit.**

The illumination lamp on the unit flashes about 30 seconds.

- During this period, the unit starts up the HDD and accepts no operations.

Connecting a TV with the audio/video jacks

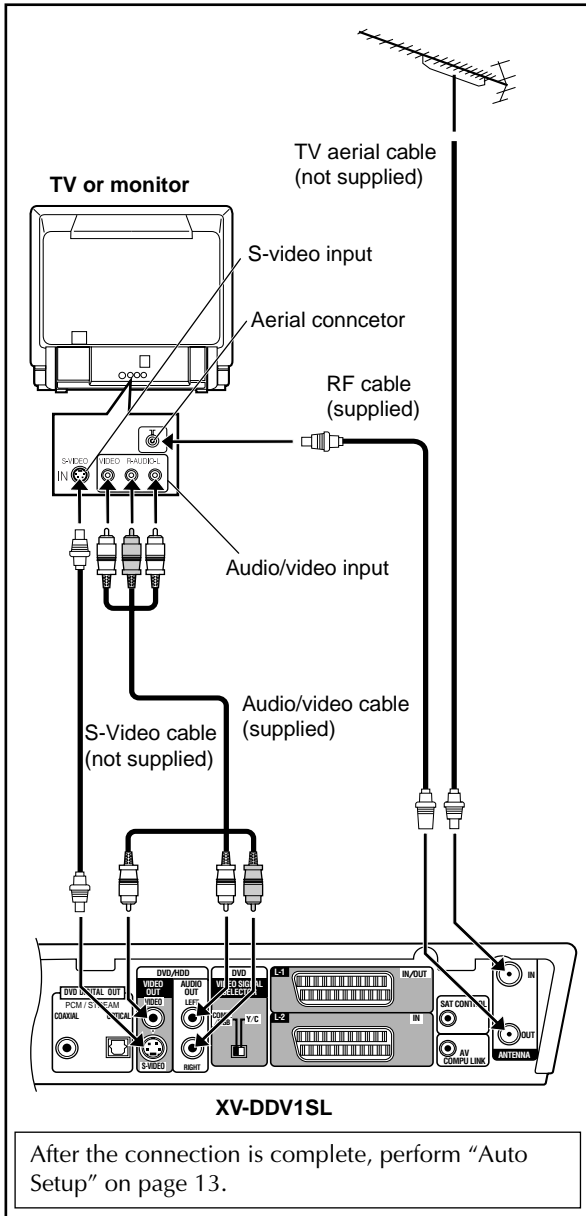

- 1 Disconnect the TV aerial cable from the TV.
- 2 Connect the TV aerial cable to the ANTENNA IN connector on the rear.
- 3 Connect the RF cable (supplied) between the ANTENNA OUT connector on the rear and the TV's aerial connector.
- 4 Connect one of the VIDEO OUT jacks (either VIDEO or S-VIDEO) on the rear to the TV's VIDEO or S-VIDEO input jack.

NOTE
 You can obtain high-quality pictures by using S-VIDEO connection.

- 5 Connect the AUDIO OUT (LEFT/RIGHT) jacks to the TV's AUDIO IN jacks.
- 6 Plug in the unit.

The illumination lamp on the unit flashes about 30 seconds.

- During this period, the unit starts up the HDD and accepts no operations.

To connect this unit to a satellite receiver, and a stereo system (see pages 86 and 87).

Precautions on connecting the power cord

- Warning**
- Disconnect the power cord:
 - if you are not going to use the unit for a long time.
 - before cleaning the unit.
 - before moving the unit.
 - Do not:
 - connect or disconnect the power cord with wet hands.
 - pull the power cord when disconnecting it, as this may damage the cord and cause fire, electric shock, or other accidents.
- Caution**
- Do not alter, twist or pull the power cord, or put anything heavy on it, which may cause fire, electric shock, or other accidents.
 - If the cord is damaged, consult a dealer and have the power cord replaced with a new one.

Easy & simple setup

Presetting the built-in TV tuner automatically—Auto Setup

Before starting, make sure of the following:

- The TV aerial cable is connected firmly to the unit.
- The AC power cord is plugged in.
- An appropriate input (AV) mode is selected on the TV.

First time you turn on the power, the unit automatically shows the Auto Setup screen. Store the TV stations (programme positions), clock time and Guide Program numbers using this screen first.

When using the remote control, slide the **DVD/TV/HDD** selector to the right (**HDD**), then **ENTER**.

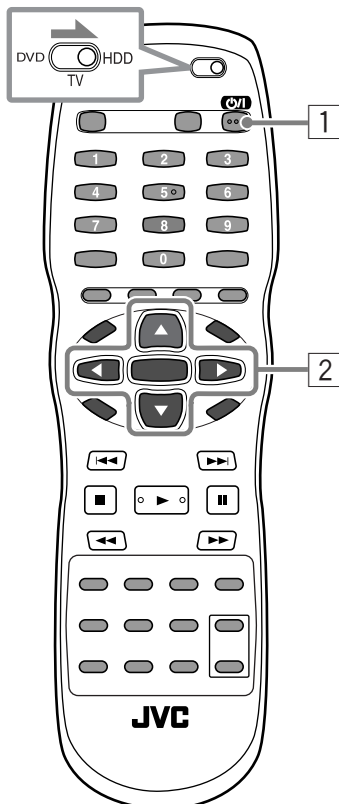
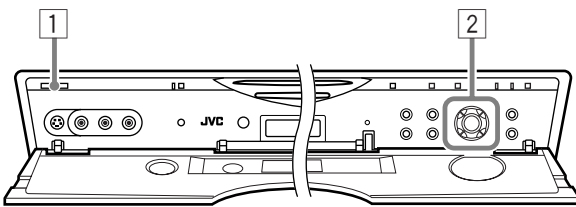

1 Turn on the power.

Press **STANDBY/ON** on the unit or **STANDBY/ON** on the remote control.

- The **AUTO SET/T-V LINK** screen appear on the TV.

2 Start Auto Setup.

Press **▲** or **▼** to move **ENTER** to "AUTO SET," then press **ENTER** or **▶**.

- **AUTO SET** screen appears. As Auto Setup progresses, the "■" mark on the TV moves from left to right. ("Au To" starts flashing in the display window.)
- When Auto Setup is completed, "SCAN COMPLETED" appears for about 5 seconds. The display window shows the clock time, "1" (lowest programme position number) or "— : —" in sequence as illustrated on page 15.

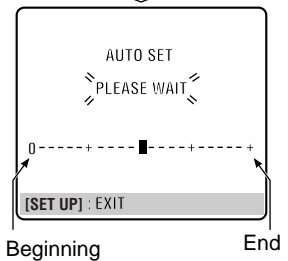
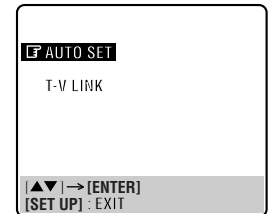

NOTE

If you have connected the unit to a TV offering T-V Link via a 21-pin SCART cable, the unit starts "TV-linked Setup" (see page 14) even if you have selected "AUTO SET."

Once you have performed Auto Setup correctly, all the stored TV stations and their Guide Program numbers will be kept in memory and the unit will not perform Auto Setup again.

- If a power failure occurs, set the clock manually (see page 69).
- If you move to a different area, or if a new station starts broadcasting in your area, perform tuner setting manually (see page 70).

NOTES

- Where no TV station transmits Programme Delivery Control (PDC) signals, the unit cannot set up the clock time and Guide Program numbers automatically.
- The unit memorizes all detected stations even if their signals are very weak. You can delete these stations with poor picture quality later manually (see "To delete a station" on page 71).
- If a power failure occurs, or if you turn off the power while Auto Setup is in progress, Auto Setup will be interrupted. If this happens, turn off the power and try again from the beginning.
- Auto Setup may fail or stored information may be incorrect if received signals are weak.
- If you press any button on the unit or on the remote control while Auto Setup is in progress, it will be cancelled.

Downloading the preset information from your TV—TV-linked Setup

If you have connected the unit to a TV offering T-V Link, etc.* (see page 11), perform TV-linked Setup instead of Auto Setup.

- After downloading TV station information from the TV, the unit sets the clock time and Guide Program numbers automatically.

NOTE

* T-V Link, EasyLink, Megalogic, SMARTLINK, Q-Link or DATA LOGIC.

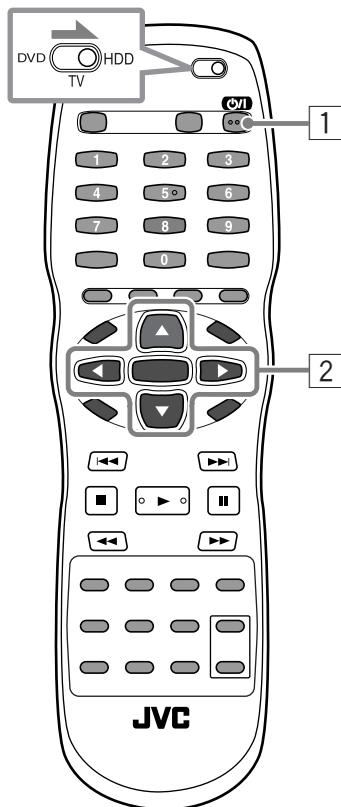
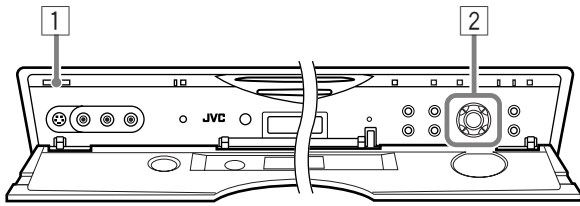

1 Turn on the power.

Press **STANDBY/ON** on the unit or **STANDBY/ON** on the remote control.

- The AUTO SET/T-V LINK screen appears on the TV.

2 Start TV-linked Setup.

Press **▲** or **▼** to move **T-V LINK** to “T-V LINK,” then press **ENTER** or **▶**.

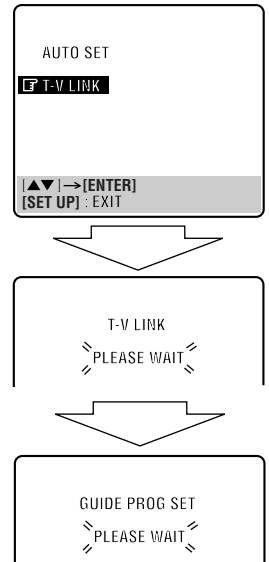

- T-V LINK screen appears for a while, then GUIDE PROG SET screen appears while setting Guide Program numbers.
- When TV-linked Setup is completed, “COMPLETED” appears for about 5 seconds. The display window shows the clock time, “1” (lowest programme position number) or “--:--” in sequence as illustrated on page 15.



NOTES

- Where no TV station transmits Programme Delivery Control (PDC) signals, the unit cannot set up the clock time and Guide Program numbers automatically.
- If a power failure occurs, or if you turn off the power while TV-Linked Setup is in progress, TV-Linked Setup will be interrupted. If this happens, turn off the power and try again from the beginning.
- Clock time setting may fail if received signals are weak.
- The characters available for station names (ID) are A–Z, 0–9, –, *, + and (space). Downloaded station names may differ from the ones listed on pages 73 and 74.
- If you press any button on the unit or on the remote control while TV-linked Setup is in progress, it will be cancelled.

If the following indications appear after Auto Setup or TV-linked Setup is over:

	<p>Auto Setup or TV-linked Setup has been successfully performed. Turn on the TV and select an appropriate input (AV) mode, then make sure that all necessary stations have been stored in memory by pressing HDD/TV PR +/- with the DVD/TV/HDD selector set to the right (HDD).</p>
	<p>TV stations have been successfully stored, but clock time setting has been failed. Turn on the TV and select an appropriate input (AV) mode, then make sure that all necessary stations have been stored in memory by pressing HDD/TV PR +/- with the DVD/TV/HDD selector set to the right (HDD).</p> <ul style="list-style-type: none"> • Set the clock time manually. See “Setting the clock time” on page 69.
	<p>Auto Setup or TV-linked Setup has been failed. Make sure the cables are connected properly, turn off the power, then perform Auto Setup or TV-linked Setup again from the beginning.</p>

IMPORTANT

- If station names (ID: see pages 73 and 74) have been stored in memory, the station names will be displayed on the TV for about 5 seconds when you change the stations.
- If you want to set the tuner manually to add or skip some programme positions, to change programme positions, or to set or change station names, see pages 70 to 74.
- To check if the Guide Program numbers have been set correctly, perform the VIDEO PLUS+[®] Timer programming (see page 40). If the Guide Program numbers have not been set correctly, the unit will record a TV programme of an unexpected station.
- The unit is equipped with Just Clock which automatically adjusts the clock time at a regular interval, by reading data from PDC signals. To use this function, see “Just Clock” on page 69.

What you can do with T-V LINK

When you connect the unit to a TV offering T-V Link, etc.* using a fully-wired 21-pin SCART cable, you can use the following functions. For details, refer also to the instruction manual of your TV.

* T-V Link, EasyLink, Megalogic, SMARTLINK, Q-Link or DATA LOGIC. The degree of compatibility and available functions may differ by system.

TV Auto Power On

The TV will turn on and an appropriate input (AV) mode is automatically selected on the TV whenever you start HDD playback on this unit.

- When you start playing the DVD player, this function does not work.

Auto Standby

You can use your TV's remote control to turn off the unit.

- For details, refer to the instruction manual of your TV.

Direct Rec

You can easily start recording the programme that you are watching on your TV (not through the TV tuner built in this unit). To use this function, set “DIRECT REC” to “ON” (see page 67).

If you have any difficulty with the above procedures, call the JVC Customer Service Hot Line on 0870 330 5000

Selecting the playback source

This unit consists of two main components—the HDD deck and the DVD player.

- For detailed operations about the HDD, see pages 21 to 46.
- For detailed operations about the DVD player, see page 47 to 65.

Before performing any operations:

- Turn on the TV and select an appropriate input (AV) mode.
- During the following periods, the unit will not accept any button operation:
 - If the unit is plugged in: For about 30 seconds. The illumination lamp on the unit flashes during this period. **During this period, disc insertion will not be accepted either.**
 - If the unit is turned on with the HDD deck selected: For about 20 seconds. During this period, the opening screen appears.

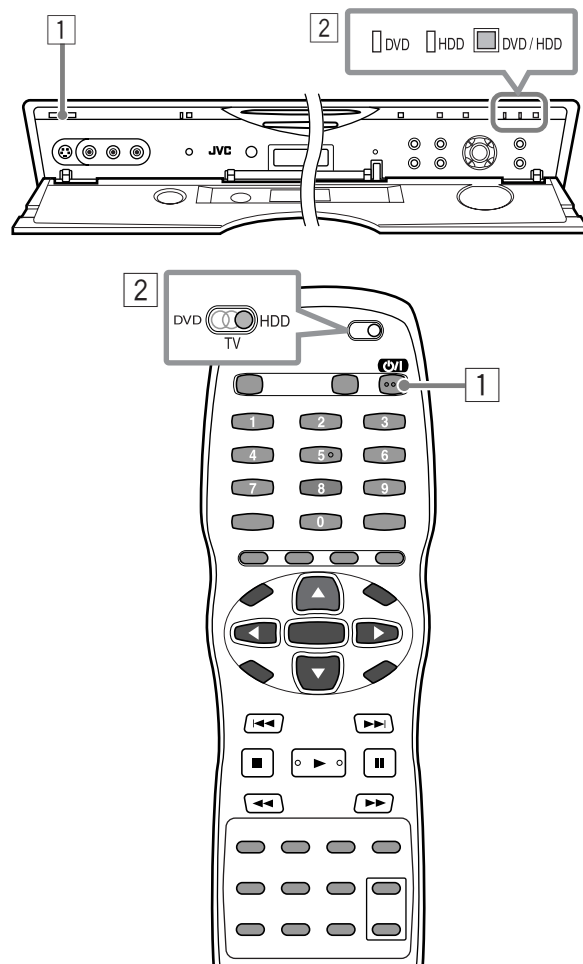

1 Turn on the power.

On the remote control

Press **⏻**.

On the unit

Press **⏻** **STANDBY/ON**.

- The lamp corresponding to the previously selected playback source (either DVD or HDD) lights on the unit.
- First time you turn on the power, the AUTO SET/T-V LINK screen appear on the TV. (See page 13.)

2 Select the either HDD deck or DVD player.

On the remote control

- ① Set the **DVD/TV/HDD** selector to the respective position—either to the right (**HDD**) or to the left (**DVD**).
- ② Press **ENTER**.
 - You can also press **LIVE** for the HDD deck.

On the unit

Press **DVD/HDD** so that the respective lamp (either HDD or DVD) lights.

- The opening screen appears on the TV.

NOTE

When the Timer Programming or HDD Setup menu screen (see pages 40, 42, and 66) is shown on the TV, you cannot change the playback source from the HDD deck to the DVD player.

About the opening screen

The opening screen appears on the TV when you turn on the unit.

- When you start playing a disc with the DVD player selected, the following messages will be shown at the bottom of the screen.

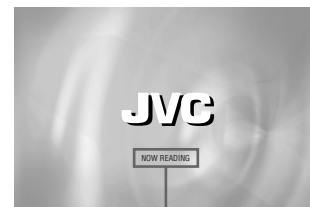

Message area

- NOW READING (The unit is reading the disc information.)
- REGION CODE ERROR! (The region code of the DVD Video disc does not match the unit. The disc cannot be played back.)
- EJECT
- LOADING
- NO DISC

Setting the satellite controller

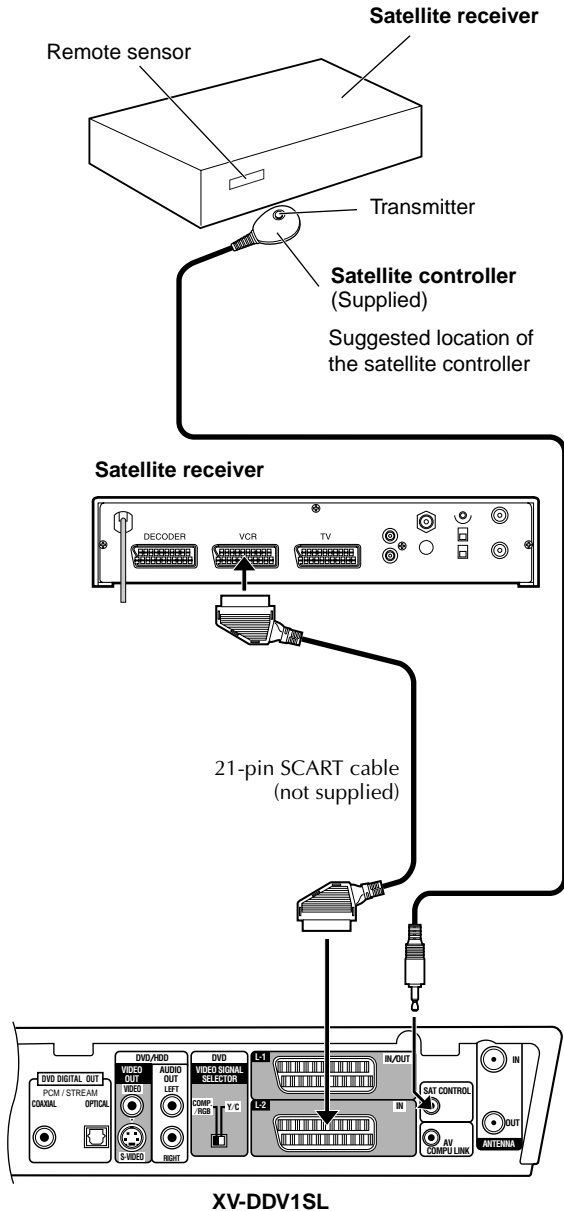

The following procedure is required if you receive satellite programmes through a satellite receiver. Approximately 20 seconds before a timer recording starts, the unit sets its input mode to "L-2" (or "SAT") and automatically changes the programme position numbers on the satellite receiver by sending a signal to your satellite receiver.

Installing satellite controller

1 Situate the satellite controller.

Place the satellite controller so that the path between its transmitter and the remote sensor on the satellite receiver is unobstructed.

2 Attach the satellite controller.

Fix securely using the adhesive strip attached on the back of the satellite controller.

3 Make connections.

Be sure to connect the L-2 IN connector on the rear to the 21-pin SCART connector on the satellite receiver.

NOTE

When connecting your satellite receiver, refer to its instruction manual.

4 Connect the satellite controller to the unit.

Connect the satellite controller to the SAT CONTROL connector on the rear.

Setting satellite receiver's brand and programme positions

After installation, set the satellite receiver's brand correctly; otherwise, the satellite controller cannot work correctly.

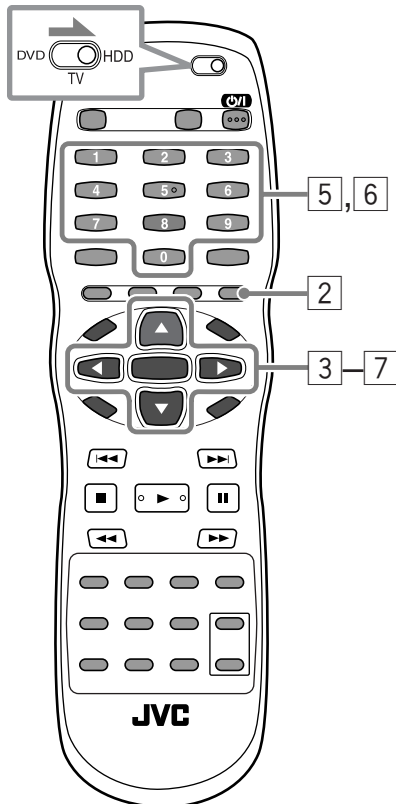

1 Turn on the satellite receiver.

2 Show the Main Setup screen on the unit.

Press **SET UP**.

- The HDD SET UP screen appears.

NOTE

If the built-in clock has not been set, the INITIAL SET UP screen appears. If this happens, set the clock first (see page 69).

3 Select the Initial Set screen.

- ① Press **▶** or **◀** to move **◀** to "INITIAL SET UP," then press **▼**.
- ② Press **▶** or **◀** to move **◀** to "INITIAL SET," then press **ENTER**.

4 Select the Sat Control Set screen.

Press **▲** or **▼** to move **◀** to "SAT CONTROL SET," then press **ENTER** or **▶**.



5 Enter the satellite receiver's brand.

Press the appropriate **number** buttons to enter the brand code from the list on page 19, then press **ENTER**.

- If the brand code you entered is invalid, the code field will be reset. Enter the correct brand code again.



NOTE

If the unit is playing or recording, you cannot set the brand code.

6 Select a programme position number for the satellite receiver for a test.

Press the appropriate **number** buttons to enter one of the programme positions (1 to 999) for the satellite receiver, then press **ENTER**.

- The unit makes a trial to change to the selected programme position number on the satellite receiver.



7 Check what happened on the satellite receiver.

If the satellite receiver's programme position number has changed to the same one as you set in step 6...

Press ▲ or ▼ to move \square to "CHANGED TO...", then press **ENTER** or ► to finish the setting.

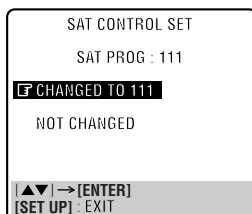

If the satellite receiver's programme position number has not changed correctly...

Press ▲ or ▼ to move \square to "NOT CHANGED," then press **ENTER** or ►. Then perform the procedure again from step 5.

- Interference from the signals sent from the remote control in step 6 may be considered as one of the causes for the unsatisfactory result. In this case, take an preventative method to avoid that interference.

NOTES

- For some satellite receivers, it is required to select 2-digit input for the programme position number entry.
- If your satellite receiver has more than two channel modes, be sure to set to "All Channel Mode." For details, refer to the instruction manual of the satellite receiver.
- The satellite controller may not be used with some types of the satellite receivers. If this is your case, leave the satellite tuner turned on and select an appropriate programme position number on the satellite receiver before the scheduled start time for a timer recording comes.
You can also use the timer equipped with your satellite receiver.

Brand name	Code
JVC	73
AMSTRAD	60, 61, 62, 63, 92
CANAL SATELLITE	81
CANAL +	81
D-BOX	85
ECHOSTAR (VIA DIGITAL)	82
FINLUX	68
FORCE	89
GALAXIS	88
GRUNDIG	64, 65, 102
HIRSCHMANN	64, 78, 99
HUMAX	88
ITT NOKIA	68
KATHREIN	70, 71, 96
LUXOR	68
MASCOM	93
MASPRO	70
NOKIA	87, 94
PACE	65, 67, 74, 86, 92
PANASONIC	74, 92
PHILIPS	66, 84, 101
RADIX	78
RFT	69
SABA	97
SAGEM	83, 90
SALORA	68
SAMSUNG	83
SIEMENS	64
SKYMASTER	69, 98
TECHNISAT	66, 100
THOMSON	97
TPS	83
TRIAx	91
WISI	64

DVD Initial Setup

Before using the built-in DVD player, activating DVD Initial Setup allows you to set up the most fundamental functions easily.

- You can set the TV monitor type and digital output signal format.

- Turn on the TV and select an appropriate input (AV) mode.
- If the unit is turned on with the HDD deck selected, it takes about 20 seconds until the broadcast picture appears on the TV. During this period, no operations are permitted.

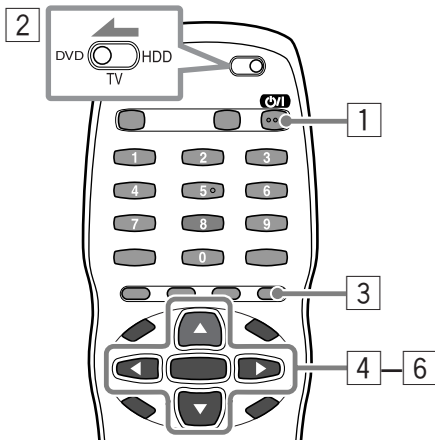
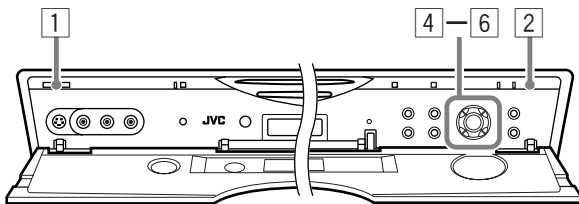

1 Turn on the power.

On the remote control

Press **ON/OFF**.

On the unit

Press **ON/OFF** **STANDBY/ON**.

- The lamp corresponding to the previously selected deck (either DVD or HDD) lights on the unit.

2 Select the DVD player.

On the remote control

① Set the **DVD/TV/HDD** selector set to the left (**DVD**).

② Press **ENTER**.

On the unit

Press **DVD/HDD** so that the DVD lamp lights.

- The opening screen appears on the TV.

3 Show the DVD PLAYER SET UP screen.

On the remote control

Press and hold **SET UP** for about 2 seconds.

- The **MONITOR TYPE** selection screen appears.

4 Select the monitor type of your TV.

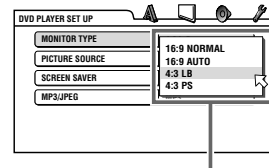

MONITOR TYPE options

Press **▲** or **▼** to move **↔** to the type of your TV, then press **ENTER**.

- For a wide-screen TV, select either "16:9 NORMAL" or "16:9 AUTO." (For details, see page 77.)
- For a conventional (4:3) TV, select either "4:3 LB" or "4:3 PS." (For details, see page 77.)
- The **DIGITAL AUDIO OUTPUT** selection screen appears.

5 Select the type of the digital signal to be emitted through the DIGITAL OUT connectors on the rear.

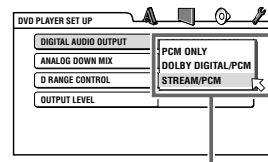

DIGITAL AUDIO OUTPUT options

Press **▲** or **▼** to move **↔** to the type you want, then press **ENTER**.

- When connecting to a recording device such as an MD recorder, and a DAT deck, select "PCM ONLY."
- When connecting to a Dolby Digital decoder, select "DOLBY DIGITAL/PCM."
- When connecting to a DTS, MPEG Multichannel, and DOLBY Digital decoder, select "STREAM/PCM."
- If you do not connect the unit to such a device, you do not have to set this item.

To bring up the DVD PLAYER SET UP screen later

Press **SET UP**.

- This allows you to perform more detailed settings (see pages 75 to 81).

Watching TV Programmes

You can watch TV programmes using the TV tuner built in the unit. One of the advantages of this behaviour so called "Live Memory."

What is Live Memory

Live Memory always records temporarily the programme (including programmes coming through the externally connected equipment) you are currently watching—**Live Memory**. So, if you want to watch a particular scene once again, you can go back to that scene and play it back. You can also pause the pictures on the TV, then continue to watch it later—**Live Memory: Playback**. Furthermore, you can go back to the beginning of the programme you are now watching and record the programme from the beginning—**Live Memory: Recording**.

- You can cancel this temporary recording or select its maximum time (see page 67).

- Turn on the TV and select an appropriate input (AV) mode.
- If the unit is turned on with the HDD deck selected, it takes about 20 seconds until the broadcast picture appears on the TV. During this period, no operations are permitted.

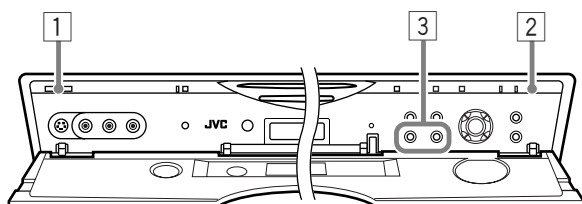
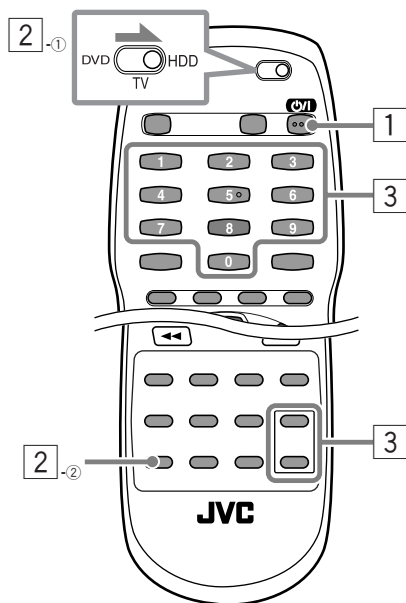

1 Turn on the power.

On the remote control

Press **POWER**.

On the unit

Press **POWER** **STANDBY/ON**.

- The lamp corresponding to the previously selected deck (either DVD or HDD) lights on the unit.

2 Select the HDD deck.

On the remote control

- Make sure that the **DVD/TV/HDD** selector set to the right (**HDD**).
- Press **LIVE** (or **EDIT**).
The HDD lamp lights on the unit.

On the unit

Press **DVD/HDD** so that the HDD lamp lights.

- The currently received programme appears on the TV. Notice that the scene shown on the TV is always a few second behind the actual on-air scene.

3 Choose a programme.

On the remote control

Press **HDD/TV PR +/-** repeatedly or the **number** buttons.

On the unit

Press **PR +/-** repeatedly.

- You can also select the external components—L-1, L-2 (or SAT), F-1.

Examples: How to use the number buttons

To select programme position 5, press **5**.

To select programme position 10, press **1**, then **0**.

To select the external components, press **AUX (0)**, then **PR +/-**.

NOTES

- When you change the programme positions, it takes a few seconds to change the pictures. It is not a malfunction.
- If TV aerial is not connected, or if no programme broadcast on the current programme position, the blue-back screen appears on the TV.

To stop the picture temporarily while watching a programme—Live Memory: Playback (Pause)

When you have an unexpected visitor or telephone call, you can stop watching the current programme temporarily, then continue it from where you have stopped.

Press II on the remote control to temporarily stop the scene shown on the TV.

To restart the programme, press **▶ (SELECT)**.

- You can watch the programme without missing any portion of the programme (the pictures you watch now are behind actual on-air scenes by the time you have paused the programme for).

To resume actual on-air scenes, press **■ (CLEAR)** or **LIVE**.

To go back to and watch from a particular scene again—Live Memory: Playback (Replay)

1. Press ◀◀ (see page 26) or ◀◀◀ (see page 27) to search for the previous scene of the current programme you are watching.
2. Press ▶ (SELECT) to start replay.

To stop playback, press ■ (CLEAR) or LIVE.

The actual on-air picture resumes.

To go back to a previous scene quickly and play it back

While watching a TV programme, press ↶.

The HDD goes back to a scene of about 7 second before, and starts replay from it.

- Each time you press the button, the HDD goes back to a previous scene of about 7 seconds before. For example, if you press the button three times, the HDD will go back to the scene of about 21 seconds before.

NOTE

You can also use other various playback features during Live Memory—Playback (see page 26).

To go back to and record from a particular scene—Live Memory: Recording

1. Press ◀◀ (see page 26) or ◀◀◀ (see page 27) to search for the previous scene of the current programme you are watching.
2. Press ■ or ▶ (SELECT) at the scene where you want to start recording.
3. Press ● (record) on the unit, or press ▶ (SELECT) while holding REC ● on the remote control to start recording. The actual on-air resumes.
 - Recording speed is automatically set to “SP.”

To stop recording, press ■ (CLEAR) twice.

NOTES

- If the reserved amount of time (or space) for Live Memory runs out, the HDD overwrites the previous recordings, starting with the oldest one.
- Temporary recording for Live Memory is erased in the following cases:
 - When you turn off the power (including a power failure).
 - When you perform a recording.
 - When you change the “LIVE MEMORY” setting (see page 67).
 - When you change the built-in TV tuner settings (see pages 70 to 74).

To show the current clock time in the display window while watching on-air scenes in real time

Press DISPLAY on the remote control.

- Each time you press the button, the channel number and clock time alternate in the display window.

Receiving stereo and bilingual programmes

The unit is equipped with a digital stereo sound decoder (NICAM) which enables reception of NICAM broadcasts. When the programme is changed, the type of broadcast being received or of signals coming in will be displayed on the TV for a few seconds (see the table below).

NOTE

When “O.S.D.” is set to “OFF,” the on-screen icons is not be shown on the TV screen (see page 67).

To change the sound you hear

Press AUDIO on the remote control repeatedly until the sound you want is selected.

- The following sound icons are shown on the TV for a few seconds to indicate the sound type you have selected.

On-screen icons	Sound you hear
	Conventional stereo sounds
	Conventional monaural sound
	Main audio track of a bilingual programme
	Sub-audio track of a bilingual programme
	NICAM stereo sounds
	NICAM monaural sound
	Main audio track of a NICAM bilingual programme
	Sub-audio track of a NICAM bilingual programme
	NICAM FM stereo sounds
	Both left and right channel sounds from externally connected equipment
	Left channel sound from externally connected equipment
	Right channel sound from externally connected equipment

To record NICAM bilingual programmes

Set “AUDIO REC” to “NICAM” to record NICAM bilingual programmes (see page 67).

Basic recording

You can store up to 100 programmes in the HDD. Once recording (including timer recordings: see pages 40 and 42) is made through the built-in TV tuner, the following information about the programme is automatically memorized in the HDD.

- Thumbnails* (index—still picture of the beginning of the programme)
- Programme title*
- Category*
- Date and time
- Channel
- Recording speed
- Recording time

* The items marked with an asterisk (*) can be later modified using HDD Navigation (see page 34).

- Turn on the TV and select an appropriate input (AV) mode.
- If the unit is turned on with the HDD deck selected, it takes about 20 seconds until the broadcast picture appears on the TV. During this period, no operations are permitted.
- You cannot record from the built-in DVD player onto the HDD.

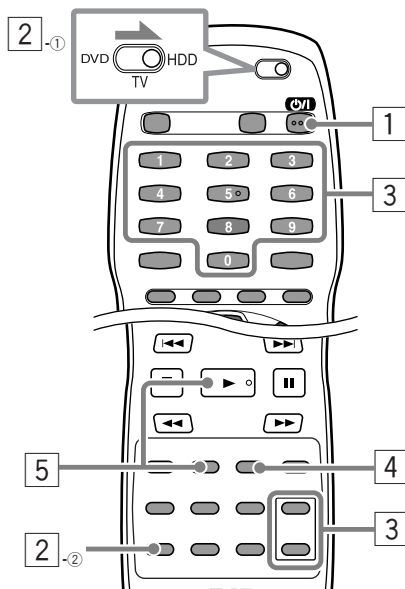
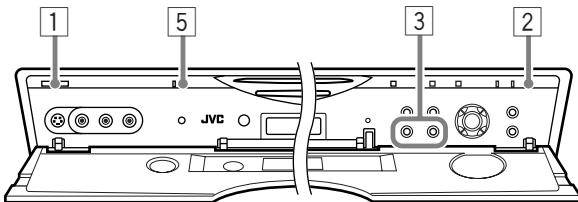

1 Turn on the power.

On the remote control

Press .

On the unit

Press **STANDBY/ON**.

- The lamp corresponding to the previously selected deck (either DVD or HDD) lights on the unit.

2 Select the HDD deck.

On the remote control

① Make sure that the **DVD/TV/HDD** selector set to the right (**HDD**).

② Press **LIVE**.

The HDD lamp lights on the unit.

On the unit

Press **DVD/HDD** so that the HDD lamp lights.

- The currently received programme appears on the TV. Notice that the scene shown on the TV is always a few second behind the actual on-air scene.

3 Choose a programme.

On the remote control

Press **HDD/TV PR +/-** repeatedly or the **number** buttons.

On the unit

Press **PR +/-** repeatedly.

- You can also select the external components—L-1, L-2 (or SAT), F-1.

Examples: How to use the number buttons

To select programme position 5, press **5**.

To select programme position 10, press **1**, then **0**.

To select the external components, press **AUX (0)**, then **PR +/-**.

NOTES

- When you change the programme positions, it takes a few seconds to change the pictures. It is not a malfunction.
- When connecting a TV with TV-Link or with equivalent function (see page 15) using the SCART cable, select "OFF" for "DIRECT REC" (see page 67) in order to record S-Video signals through the L-2 IN or INPUT F-1 connector.

4 Set the recording speed.

On the remote control only

Press **REMAIN/REC MODE** on the remote control.

- For details on the recording speed, see page 24.

5 Start recording.

On the remote control

Press and hold **REC** , then press **▶**.

On the unit

Press (record).

- The lamp next to the (record) button lights.

To stop recording

Press ■ (CLEAR) once so that the confirmation message appears on the TV. Then press ■ (CLEAR) again.

- The lamp next to the ● (record) button goes off.

NOTES

- In the middle of a recording, you can start playing back the same programme (just currently being recorded) from the beginning or pause the picture shown on the TV at a particular scene. (Recording continues although you start playback or pause the TV screen picture). See “Live Memory: Playback (Pause)” on pages 21 and “Live Memory: Playback (Replay)” on page 22.
- It is impossible to pause an actual recording while recording a programme other than from “L-1,” “L-2 (or SAT),” and “F-1” (see pages 83 to 85).

To record NICAM bilingual programmes

Set “AUDIO REC” to “NICAM” to record NICAM bilingual programmes (see page 67).

Watching another programme while recording

1. Press TV/VIDEO on the remote control so that the VIDEO lamp (inside the front panel) goes off.
2. Select another programme position on the TV.

Changing the recording speed

You can also check the current recording time and remaining time in the HDD.

Each time you press REMAIN/REC MODE, the recording speed changes as follows:

- First time you press the button, the remaining time in the HDD and the current recording speed alternate in the display window.

Recording speed	Recording quality (approx.)	Total recording time (approx.)*
SP	6.4 Mbps	20 hours
LP	4.5 Mbps	28 hours
EP	3.2 Mbps	56 hours
SEP	2.2 Mbps	80 hours

* When “LIVE MEMORY” is set to “OFF” (see page 67).

- When “O.S.D.” is set to “ON” (see page 67), the following screen also appears on the TV screen.

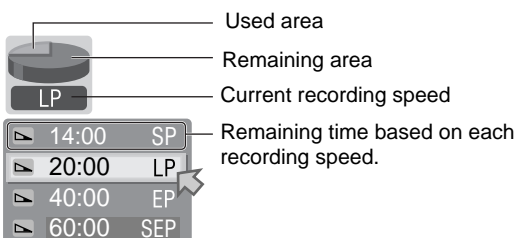

NOTES

- The capacity of the HDD is 80 Gbytes.
- MPEG2 format is used for the HDD recording format—the same one used for DVD Video discs.
- “bps” is used to represent how much data can be recorded per second. The larger this value is, the better the picture quality is, but the more capacity is required for recording. Select “SP” for programmes where quick movement occurs, such as sports programmes, and “SEP” for talk shows, etc. where relatively less movement.

Instant Timer Recording (ITR)

This easy method lets you record for from 30 minutes to 6 hours (selectable in 30-minute increments), and turns off the power after recording is finished.

On the unit only

Press ● (record) repeatedly while recording.

Each time you press the button, recording time increases in 30-minute intervals.

- The lamp next to the ● (record) button starts flashing, and recording time appears in the display window (it counts down as recording goes on).
- ITR recording time also appears on the TV for a while when “O.S.D.” is set to “ON” (see page 67).

To stop ITR, press ■ (CLEAR) twice.

Basic playback

- Turn on the TV and select an appropriate input (AV) mode.
- If the unit is turned on with the HDD deck selected, it takes about 20 seconds until the broadcast picture appears on the TV. During this period, no operations are permitted.

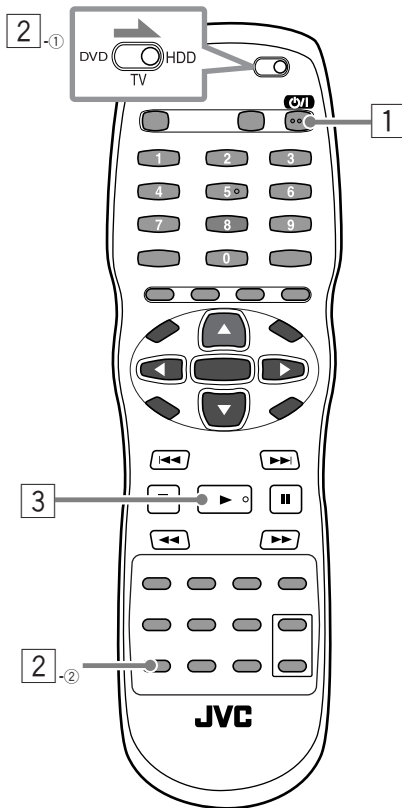
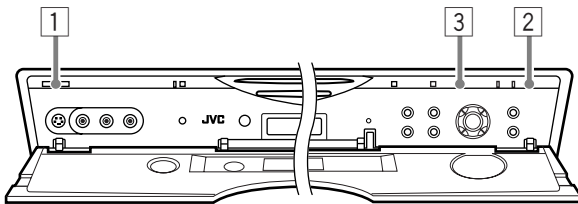

1 Turn on the power.

On the remote control

Press **⏻/⏪**.

On the unit

Press **⏻/⏪** **STANDBY/ON**.

- The lamp corresponding to the previously selected deck (either DVD or HDD) lights on the unit.

2 Select the HDD deck.

On the remote control

- ① Make sure that the **DVD/TV/HDD** selector set to the right (**HDD**).
- ② Press **LIVE**.
The HDD lamp lights on the unit.

On the unit

Press **DVD/HDD** so that the HDD lamp lights.

- The currently received programme appears on the TV.

3 Start playback.

Press **▶** (**SELECT**).

- Playback starts with...
 - the last programme recorded if it has not been played back yet.
 - the last played-back programme if it has not played back entirely.
 - the HDD Navigation screen (see page 29), or
 - some demonstration programmes for the first time you start playback.

NOTES

- When the entire programme has been played, playback stops and on-air programme is shown on the TV.
- When the programme reaches its end while searching, picture will pauses at the end.

To stop playback temporarily (Playback Pause)

Press **⏸** on the remote control.

To resume normal playback, press **▶** (**SELECT**).

To stop playback

Press **■** (**CLEAR**).

- The currently received programme appears on the TV.

To change the sound you hear

Press **AUDIO** on the remote control repeatedly until the sound you want is selected. For details, see page 22.

Special effect playback

While playing back a recorded programme, you can use the following special effect playback.

- When using the buttons on the unit, make sure that the HDD lamp on the unit is lit. If not, press **DVD/HDD** so that the HDD lamp lights.
- When using the remote control, slide the **DVD/TV/HDD** selector to the right (**HDD**), then press **ENTER**.

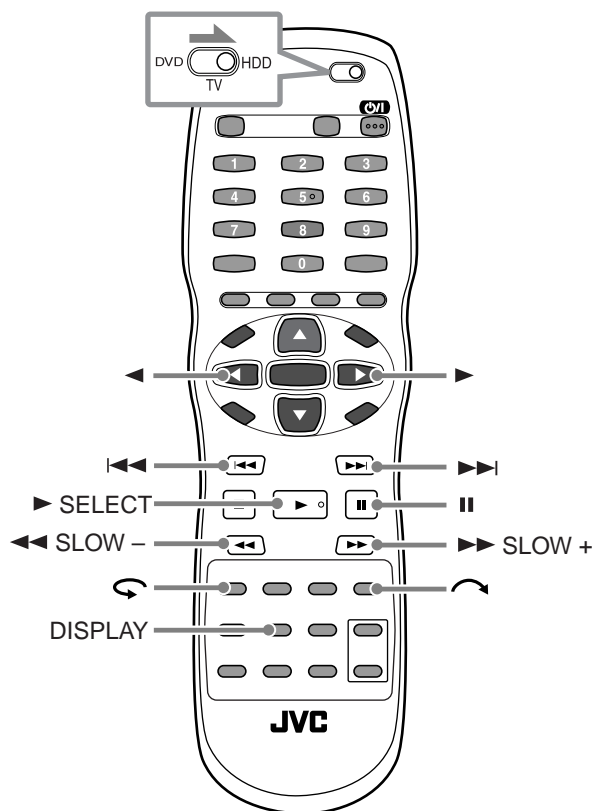
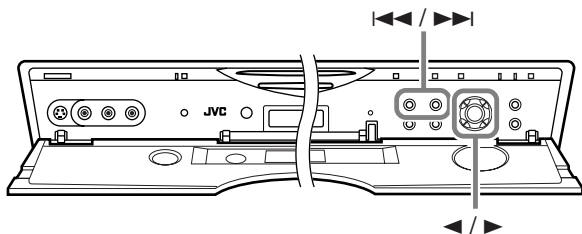

Searching for a particular scene—Variable Speed Search

You can change search speed.

- You cannot hear playback sounds during search except 1.5 times speed search.

On the remote control

While playing, press **▶▶** (SLOW +) or **◀◀** (SLOW -).

On the unit

While playing, press **▶▶** or **◀◀**.

- Each time you press the button, playback speed changes as follows:

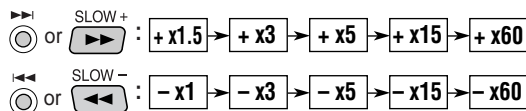

To resume normal playback, press **▶** (SELECT).

Going back to a previous scene quickly and play it back—One Touch Replay

While playing, press **↶** on the remote control.

The HDD goes back to a scene of about 7 second before, and starts replay from it.

- Each time you press the button, the HDD goes back to a previous scene of about 7 seconds before. For example, if you press the button three times, the HDD will go back to the scene of about 21 seconds before.

Skipping forward quickly—Quick Skip

While playing, press **↷** on the remote control.

The HDD skips forward (about 30 seconds at a time) and resumes playback.

This will be convenient when you want to skip a commercial in a recording.

- Each time you press the button, the HDD skips the recorded portion of about 30 seconds that follows. For example, if you press the button three times, the HDD will skip the following portion of about 1 minute and 30 seconds.

Skipping forward or backward at certain time intervals—Jump Search

You can locate a scene ahead or behind the current one by jumping to a selected time interval (see page 67).

- This feature is also available during recording.

While playing (or recording), press ►► (cursor ►) or ◀◀ (or cursor ◀).

- Each time you press the button, you can move forward or backward to a selected time (15 minutes, 30 minutes, or 1 hour).
- When you cannot move any farther (beginning or end of programme is reached), the notice message appears on the TV. In such a case, press ◀◀ or ►► to cancel the last movements.

Example 1:

Jump Search during playback: When “JUMP TIME” is set to “30 MIN”:

- You can move back (or forward) to the scenes of 0 minute, 30 minute, 60 minutes, 90 minutes, 120 minutes (elapsed playing time), and so on...

Elapsed time (shaded) and remaining time (white)

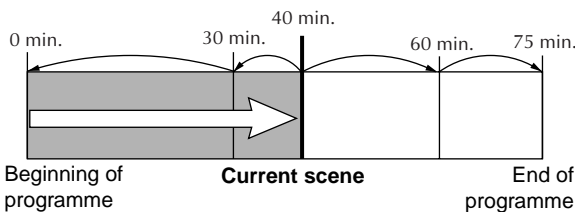

- In the above example, you can go back to a scene of 30 minutes and of 0 minute (elapsed playing time).

Example 2:

Jump Search during Live Memory Playback: When “JUMP TIME” is set to “15 MIN”:

- You can move to the scenes of 0:00, 0:15, 0:30, 0:45 of the broadcasting hour.

Elapsed time (shaded) and traced time from the current time

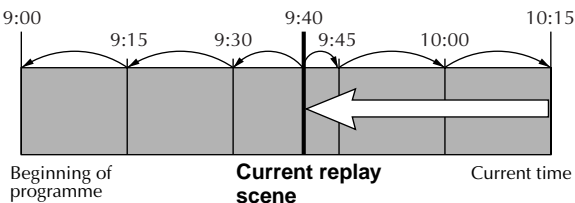

- In the above example, you can move to the scenes of 9:00, 9:15, 9:30, 9:45, 10:00, and 10:15.

Freezing the picture and advance it frame by frame—Still Picture/Frame-by-Frame Playback

You can show the still picture, and advance or reverse it frame by frame.

- You cannot hear playback sounds during Still Picture and Frame-by-Frame Playback.

- 1 Press **II** to freeze the picture on the TV.
- 2 Press **►► (SLOW +)** or **◀◀ (SLOW -)** repeatedly to advance or reverse the still picture.

To resume normal playback, press **► (SELECT)**.

Playing in slow motion—Slow Motion

You can select the slow motion speed.

- You cannot hear playback sounds during Slow Motion.

- 1 Press **II** to freeze the picture on the TV.
- 2 Press and hold **SLOW + (►►)** or **SLOW - (◀◀)** for about 2 seconds to start slow motion playback.

- Each time you press the button, playback speed changes as follows:

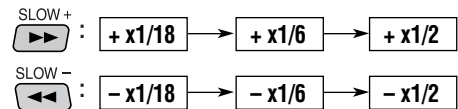

To resume normal playback, press **► (SELECT)**.

Repeating the same programme—Repeat Play

You can repeat the same programme repeatedly using HDD Navigation.

- For detailed operations, see “Playing with HDD Navigation” on pages 29 to 33.

Confirming various information on the TV

With "O.S.D." set to "ON" (see page 67), various operational information automatically appears on the TV for a while when you operate the HDD deck.

You can also show the operational information manually without respect to the "O.S.D." setting.

Press ON SCREEN.

- Each time you press the button, the following information screen turns on and off on the TV alternately.

When watching (or recording) a TV programme through this unit

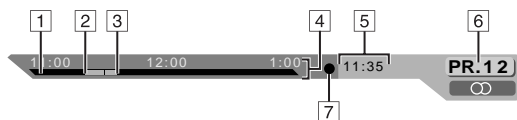

- 1 Start point from where Live Memory can be played back
- 2 Start point from where Live Memory can be recorded (The current programme has been selected at this point.)
- 3 Current scene
- 4 Time scale
- 5 Current time
- 6 Current programme position number
- 7 Record (●) indicator only during recording

NOTE

While recording, the recording speed/remaining time and elapsed recording time for the current recording also appear.

When playing Live Memory during playback

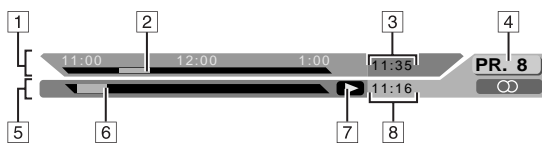

- 1 Time scale for temporary recording
- 2 Current scene being recorded
- 3 Current time
- 4 Current programme position number
- 5 Time scale for Live Memory
- 6 Current playback point
- 7 Live Memory: Playback indicator
- 8 Current playback time

When playing Live Memory during recording



- 1 Current scene being recorded
- 2 Live Memory: Recording indicator

When playing back a recorded programme (see page 29)

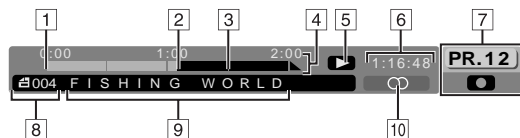

- 1 Programme start point
- 2 Current playback point
- 3 Programme end point
- 4 Time scale (This programme is an hour and a half long.)
- 5 Playback status indicator (ex. play)
- 6 Elapsed playing time
- 7 Current programme position number (being recorded internally)
 - Appears only when recording is performed internally.
- 8 Recorded programme (or play list) number currently being played back
- 9 Title of programme currently being played back
- 10 Sound you hear (see page 22)

Playing with HDD Navigation

Each time a recording is made, the information (for example, thumbnail picture—index) about the recording is also memorized in the HDD.

You can confirm the information about the recordings memorized in the HDD using HDD Navigation. Moreover, you can select and start playing one of the recordings stored in the HDD.

Using HDD Navigation, you can use the following four main functions:

- **To select a favourite programme from the recording list (REC LIST)**
 - You can also arrange the playback order of your favourite programmes.
- **To select the best collections (play lists) consisting of your favourite scenes (PLAY LIST)**
 - Preparation: you need to make your own play lists (see page 37).
- **To select your favourite programmes from the preset genres (CATEGORY)**
 - Preparation: you need to categorize the recorded programmes into the preset genres (see page 35).
- **To search the programmes by entering their titles (TITLE)**
 - Preparation: you need to assign the titles to the recorded programmes (see page 36).

When you press **HDD NAVIGATION**, the following screen appears. Before operating it any further, be familiar with the icons used on this screen.

NAVIGATION screen (entrance to HDD Navigation)

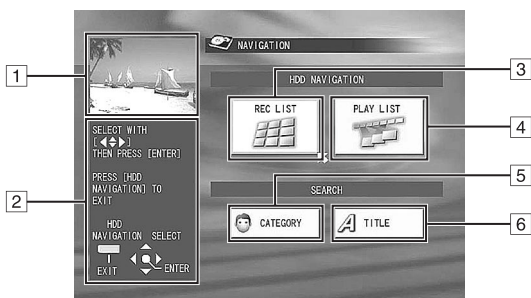

- 1 Viewing window
(Shows currently received TV programme.)
- 2 Guidance for operations
- 3 REC LIST icon: select to enter the REC LIST screen
- 4 PLAY LIST icon: select to enter the PLAY LIST screen.
- 5 CATEGORY icon: select to enter the CATEGORY screen.
- 6 TITLE icon: select to enter the TITLE screen.

Main List screen (ex. REC LIST)



- 1 Viewing window
(Shows currently received TV programme.)
- 2 Guidance for operations
- 3 Scroll bar
Appears to indicate when more than nine programmes (or play lists) are registered. To show hidden programmes (or play lists), press ► / ◀ / ▼ / ▲ repeatedly.
- 4 Recording information for the programme indicated by the arrow
- 5 Thumbnail (Index—still picture of each programme)*
- 6 Thumbnail marks
 - ☐: Indicates no thumbnail is registered.
 - ⌚: Indicates that programme now stands by for timer recording.
 - 📺: Indicates no programme is registered.
- 7 Icons (see the table that follows.)

The icons used on the Navigation screens and their meanings

	This programme has never been played back (or it may be now being recorded when this icon is shown).
	This programme has been recorded using daily timer recording (daily overwrite).
	This programme has been recorded using daily timer recording (weekly overwrite).
	This programme has been recorded using weekly timer recording (weekly overwrite).
	This programme is stereo.
	This programme is bilingual.
	This programme has been recorded using recording timer.

* The NAVIGATION screens can show only nine thumbnails at a time. By pressing ► / ◀ / ▼ / ▲ repeatedly, you can show the unshown thumbnails.

To move to the first or last recorded thumbnail, press ◀◀ / ▶▶ on the remote control or ◀◀ / ▶▶ on the unit.

Selecting programmes on the NAVIGATION screen

This HDD can store up to 100 recordings.

You can show the beginnings of these recorded programmes on the HDD Navigation screen, and select one to play or select some to play in your intended order.

- When using the buttons on the unit, make sure that the HDD lamp on the unit is lit. If not, press **DVD/HDD** so that the HDD lamp lights.
- When using the remote control, slide the **DVD/TV/HDD** selector to the right (**HDD**), then press **ENTER**.
- HDD Navigation does not work during Automatic Satellite Recording (see page 46).

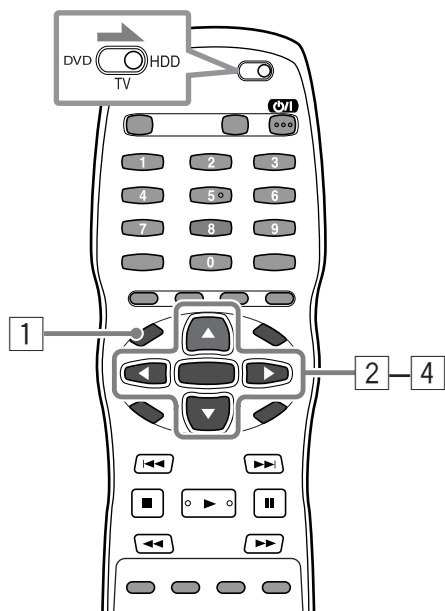
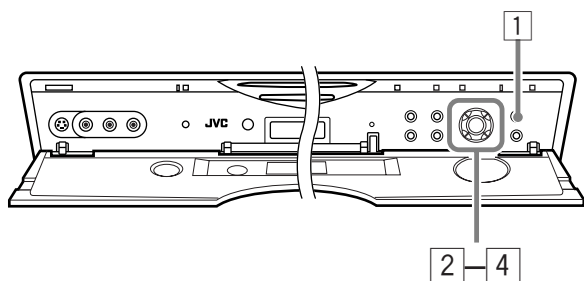

To go back to the previous screen while operating HDD Navigation, press **RETURN**.

Playing back a programme or a play list

All recorded programmes (except the programmes being recorded temporarily) are automatically listed on the REC LIST. On the other hand, you need to make your own play lists yourself.

- On the **PLAY LIST**, you can register your own play lists. For details about how to make a play list, see page 37.

1 Show the NAVIGATION screen.

Press **HDD NAVIGATION**.



2 Enter the REC LIST or PLAY LIST screen.

Press **▶** or **◀** to move **↔** to "REC LIST" or "PLAY LIST," then press **ENTER**.

- The REC LIST or PLAY LIST screen appears.



Ex. When selecting REC LIST

3 Select a programme to play.

Press **▶** / **◀** / **▼** / **▲** to move **↔** to a thumbnail you want, then press **ENTER**.

- The playback selection screen appears.



4 Start playback.

Press **▶** or **◀** to move **↔** to one of the playback modes (see the table below), then press **ENTER**.

BEGINNING	Select to start playback from the beginning.
RESUME	Select to start playback where you have stopped last.
REPEAT	Select to repeat the same programme. Repetition continues until you stop it.

NOTE

You cannot select "RESUME" for newly recorded programme (with **NEW** icon).

To stop playback

Press **■** (**CLEAR**).

- When you select Repeat Play ("REPEAT"), pressing **▶** (**SELECT**) cancels the repeat, and resumes normal playback.

Playing back two or more programmes in your desired order

You can select up to eight programmes for continuously. This is convenient when you want to watch a series of dramas.

- When using the buttons on the unit, make sure that the HDD lamp on the unit is lit. If not, press **DVD/HDD** so that the HDD lamp lights.
- When using the remote control, slide the **DVD/TV/HDD** selector to the right (**HDD**), then press **ENTER**.
- HDD Navigation does not work during Automatic Satellite Recording (see page 46).

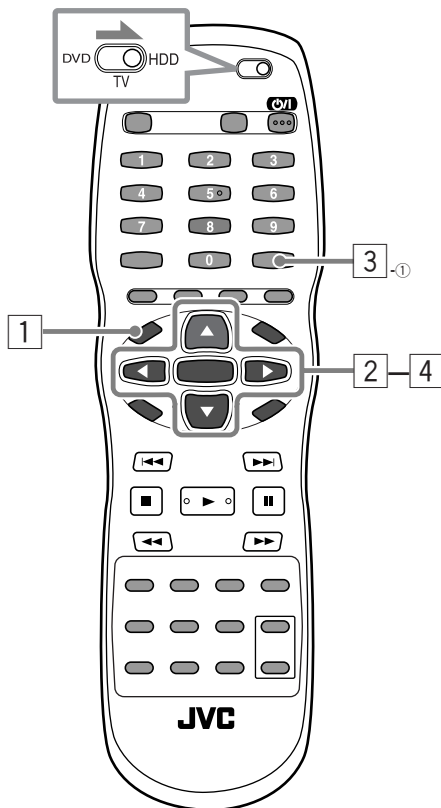

1 Show the NAVIGATION screen.

Press **HDD NAVIGATION**.

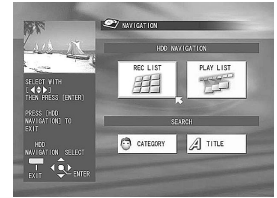

2 Enter the REC LIST or PLAY LIST screen.

Press **▶** or **◀** to move **↔** to "REC LIST" or "PLAY LIST," then press **ENTER**.

- The REC LIST or PLAY LIST screen appears.



3 Select the programmes to play in your desired order.

- Press **▶** / **◀** / **▼** / **▲** to move **↔** to a thumbnail you want, then press **MEMORY**.
 - Playback order number is assigned and is shown on the thumbnail.



- Repeat step ① to select more thumbnails.

To move to the first or last recorded thumbnail, press **◀◀** / **▶▶**.

4 Start playback.

Press **ENTER**.

- Programmes are played in the selected order.

To stop playback

Press **■** (**CLEAR**).

Searching for a programme in your favourite category—CATEGORY

You can easily search for a programme or a play list if it is grouped into a particular category.

There are two types of categories: “Genre” and “Family.” as sub-categories, “Genre” includes 16 groups while “Family” can include the maximum of 8 family members.

- To categorize a programme or a play list into a particular group, see page 35.

You can also categorize a programme while setting the recording timers (see pages 41 and 43).

To set your family members as groups in “Family,” see “Changing the HDD/TV tuner settings” on page 66.

- When using the buttons on the unit, make sure that the HDD lamp on the unit is lit. If not, press **DVD/HDD** so that the HDD lamp lights.
- When using the remote control, slide the **DVD/TV/HDD** selector to the right (**HDD**), then press **ENTER**.
- HDD Navigation does not work during Automatic Satellite Recording (see page 46).

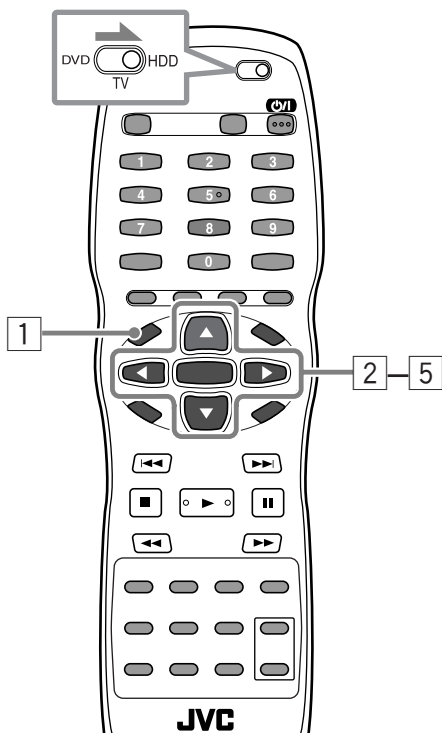
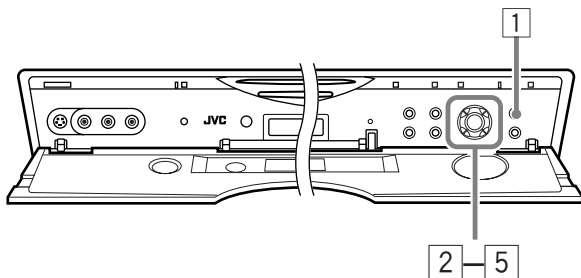

1 Show the NAVIGATION screen.

Press **HDD NAVIGATION**.

2 Enter the CATEGORY screen.

Press **▶/◀/▼/▲** to move **↔** to “CATEGORY,” then press **ENTER**.



3 Select a category.

Press **▶/◀/▼/▲** to move **↔** to a category name you want, then press **ENTER**.

- The screen can show only 15 categories at a time. By pressing **▼/▲** repeatedly, you can show other categories.



Thumbnails registered in the category appear.

4 Select a programme to play.

Press **▶/◀/▼/▲** to move **↔** to a thumbnail you want, then press **ENTER**.

- The playback selection screen appears.

5 Start playback.

Press **▶** or **◀** to move **↔** to one of the playback modes (see the table below), then press **ENTER**.

BEGINNING	Select to start playback from the beginning.
RESUME	Select to start playback where you have stopped last.
REPEAT	Select to repeat the same programme. Repetition continues until you stop it.

NOTE

You cannot select “RESUME” for newly recorded programme (with **NEW** icon).

To stop playback

Press **■ (CLEAR)**.

- When you select Repeat Play (“REPEAT”), pressing **▶ (SELECT)** cancels the repeat, and resumes normal playback.

Searching for a programme by its title—TITLE

You can easily search for a programme or a play list if it has its own title.

- To assign a title to a programme or a play list, see pages 36 and 39.

You can also assign a title while setting the recording timers (see pages 41 and 43).

- When using the buttons on the unit, make sure that the HDD lamp on the unit is lit. If not, press **DVD/HDD** so that the HDD lamp lights.
- When using the remote control, slide the **DVD/TV/HDD** selector to the right (**HDD**), then press **ENTER**.
- HDD Navigation does not work during Automatic Satellite Recording (see page 46).

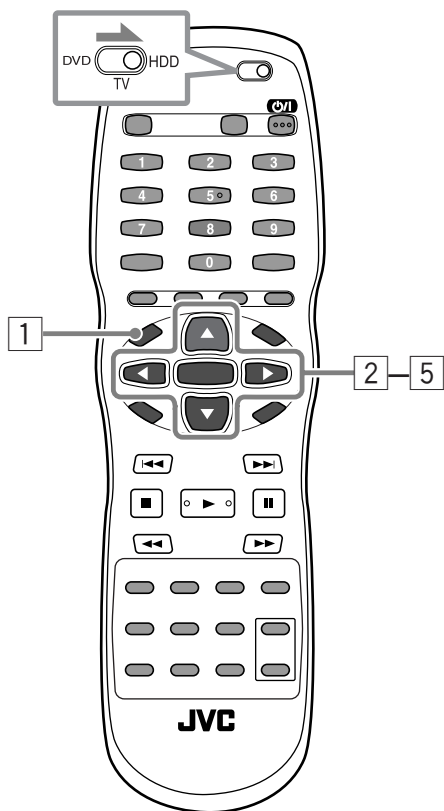
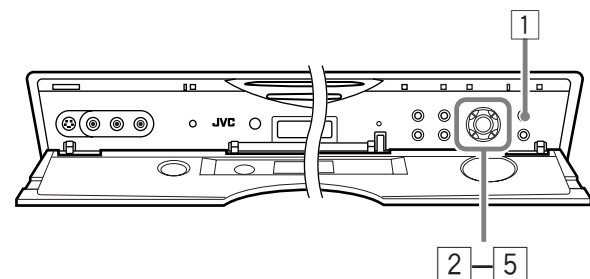

1 Show the NAVIGATION screen.

Press **HDD NAVIGATION**.

2 Enter the TITLE screen.

Press **▶ / ◀ / ▼ / ▲** to move **↔** to "TITLE," then press **ENTER**.

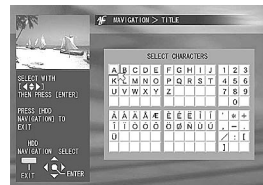

3 Select the initial letter of the title.

Press **▶ / ◀ / ▼ / ▲** to move **↔** to the initial letter of the title, then press **ENTER**.



- Thumbnails which have the selected initial letter in their titles appear.
- If no programmes or no play lists with the selected letter are found, those with the next alphabetical letter will appear.

4 Select a programme to play.

Press **▶ / ◀ / ▼ / ▲** to move **↔** to a thumbnail you want, then press **ENTER**.

- The playback selection screen appears.

5 Start playback.

Press **▶** or **◀** to move **↔** to one of the playback modes (see the table below), then press **ENTER**.

BEGINNING	Select to start playback from the beginning.
RESUME	Select to start playback where you have stopped last.
REPEAT	Select to repeat the same programme. Repetition continues until you stop it.

NOTE

You cannot select "RESUME" for newly recorded programme (with **NEW** icon).

To stop playback

Press **■** (**CLEAR**).

- When you select Repeat Play ("REPEAT"), pressing **▶** (**SELECT**) cancels the repeat, and resumes normal playback.

Editing HDD Navigation

In the previous section you have learned how to search for the beginning of each recorded programme or of each play list using HDD Navigation.

In this section you will learn how to edit the programme and how to make a play list. You can edit HDD Navigation using the following screen.



• REC LIST

- MODIFY: To make modifications to a recorded programme (right column).
- DELETE: To delete a recorded programme (see page 36).
- DIVIDE: To divide a recorded programme (see page 37).

NOTES

- If the HDD is full or 100 programmes are already stored, you cannot divide a programme.
- In the following cases, you cannot divide a programme (it will not be shown on the REC LIST/DIVIDE screen):
 - If it is being record now.
 - If it has been record daily or weekly.
 - If it is used as an element of a play list.

• PLAY LIST

- MODIFY: To make modifications to a list (see page 39).
- DELETE: To delete a list (see page 39).
- CREATE: To create a new list by editing the recorded programmes (see page 37).

To go back to the previous screen while editing HDD Navigation, press **RETURN**.

Modifying recorded programmes

HDD Navigation does not work during Automatic Satellite Recording (see page 46).

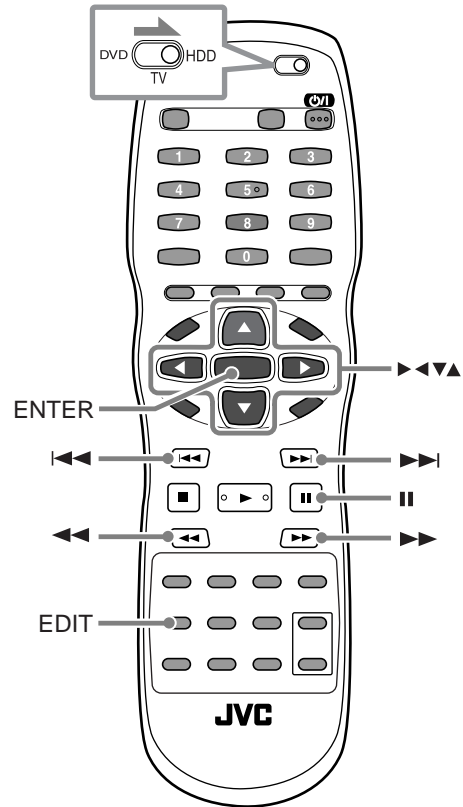

To use your favourite scene for the thumbnail

1 Show the EDIT screen.

Press **EDIT**.







2 Enter the REC LIST/MODIFY screen.

- Make sure that  is pointing at "MODIFY" under "REC LIST."
- Press **ENTER**.
 - The REC LIST/MODIFY screen appears.





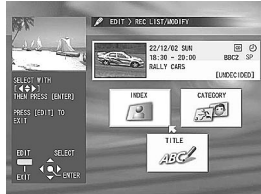

3 Select a programme.

- Press  /  /  /  to move  to a thumbnail you want, then press **ENTER**.
- The main modification screen appears.





4 Change the thumbnail.

- Press **ENTER** after making sure that  is pointing at "INDEX."
- Press **II** where the scene you want to use as a thumbnail appears.
 - You can use , , and  to search for your favourite scene.
- Press **ENTER** after making sure that  is pointing at "REPLACE."



NOTE

If you want to continue other modifications —CATEGORY and TITLE, press  or  to move  to "RETUN." The main modification screen appears again.







- To change the category, go to step [2](#) of the right column.
- To change the title, go to step [2](#) on page 36.

5 Finish the procedure.

Press **EDIT**.

To change the category (or to categorize a programme)

1 Show the main modification screen.





- Press **EDIT**.
- Press **ENTER** after making sure that  is pointing at "MODIFY" under "REC LIST."
- Press  /  /  /  to move  to a thumbnail you want, then press **ENTER**.

2 Enter the category selection screen

Press  /  /  /  to move  to "CATEGORY," then press **ENTER**.



3 Select a new category.

Press  /  /  /  to move  to a new category you want, then press **ENTER**.



- The thumbnail is grouped into the selected category, and the main modification screen appears again.

4 Finish the procedure.

Press **EDIT**.

To change (or newly assign) the title

1 Show the main modification screen.





- ① Press **EDIT**.
- ② Press **ENTER** after making sure that  is pointing at "MODIFY" under "REC LIST."
- ③ Press **▶** / **◀** / **▼** / **▲** to move  to a thumbnail you want, then press **ENTER**.

2 Enter the title entry screen.

Press **▶** / **◀** / **▼** / **▲** to move  to "TITLE," then press **ENTER**.

- The EDIT>TITLE screen appears.

3 Enter a new title.

- To enter the characters, press **▶** / **◀** / **▼** / **▲** to move  to a desired character, then press **ENTER**. (Repeat this until you enter the entire title (the maximum of 26 characters))
- To enter a space, press **▶** / **◀** / **▼** / **▲** to move  to an empty square in the character table, or to ">," then press **ENTER**.
- To delete and correct a misentry:
 - ① Press **▶** / **◀** / **▼** / **▲** to move  to "<" or ">," then press **ENTER** repeatedly until the incorrect character is selected.
 - ② Press **▶** / **◀** / **▼** / **▲** to move  to "DELETE," then press **ENTER**.
The entered characters following the deleted one moves leftward.
 - ③ Press **▶** / **◀** / **▼** / **▲** to move  to a correct character, then press **ENTER**.

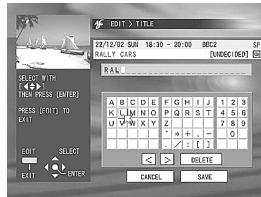

4 Save the title.

Press **▶** / **◀** / **▼** / **▲** to move  to "SAVE," then press **ENTER**.

- If you want to cancel the procedure, move  to "CANCEL," then press **ENTER**.

5 Finish the procedure.

Press **EDIT**.

To delete an unnecessary programme

1 Show the EDIT screen.

Press **EDIT**.



2 Enter the REC LIST/DELETE screen.

Press **▶** or **◀** to move  to "DELETE" under "REC LIST," then press **ENTER**.

- The REC LIST/DELETE screen appears.



3 Select an unnecessary programme.

Press **▶** / **◀** / **▼** / **▲** to move  to a thumbnail you want to delete, then press **ENTER**.

- The confirmation screen appears.



4 Perform the deletion.

Press **◀** to move  to "DELETE," then press **ENTER**.

- If you want to cancel the deletion, press **▶** move  to "CANCEL," then press **ENTER**.



5 Delete more unnecessary programmes.

Repeat steps [3](#) and [4](#).

6 Finish the procedure.

Press **EDIT**.

To divide a programme

1 Show the EDIT screen.

Press **EDIT**.



2 Enter the REC LIST/DIVIDE screen.

Press **▶** or **◀** to move **⏏** to "DIVIDE" under "REC LIST," then press **ENTER**.

- The REC LIST/DIVIDE screen appears.



3 Divide a programme.

- Press **▶** / **◀** / **▼** / **▲** to move **⏏** to a thumbnail you want to divide, then press **ENTER**.
 - Playback starts in the viewing window.
 - Press **⏏** where you want to divide the programme. (You can use **▶▶**, **◀◀**, and **▶** to search for your favourite scene.)
 - Press **ENTER** after making sure that **⏏** is pointing "DIVIDE."
 - The beginning scene (thumbnail) of the newly divided portion appears in the right bottom window.
- If you want to relocate the dividing point, press **ENTER** after making sure that **⏏** is pointing at "RETRY." (You can now repeat steps ② and ③.)
 - If you want to preview the dividing point, press **▶** or **◀** to move **⏏** to "PREVIEW," then press **ENTER**. The first 8 seconds of the newly divided portion is played back.

4 Confirm the divided portion.

- Press **▶** to move **⏏** to "OK," then press **ENTER**.
 - The confirmation message appears.
- Press **◀** to move **⏏** to "DIVIDE," then press **ENTER**.
 - If you want to cancel the division, press **▶** to move **⏏** to "CANCEL," then press **ENTER**.

5 Finish the procedure.

Press **EDIT**.

Making play lists

A play list is a collection of the scenes selected from recorded programmes. A play list can be freely edited and played back without changing original programmes recorded. A play list includes information such as the beginning and ending time of the scenes, thumbnails for checking the contents, category information, and more.

HDD Navigation does not work during Automatic Satellite Recording (see page 46).

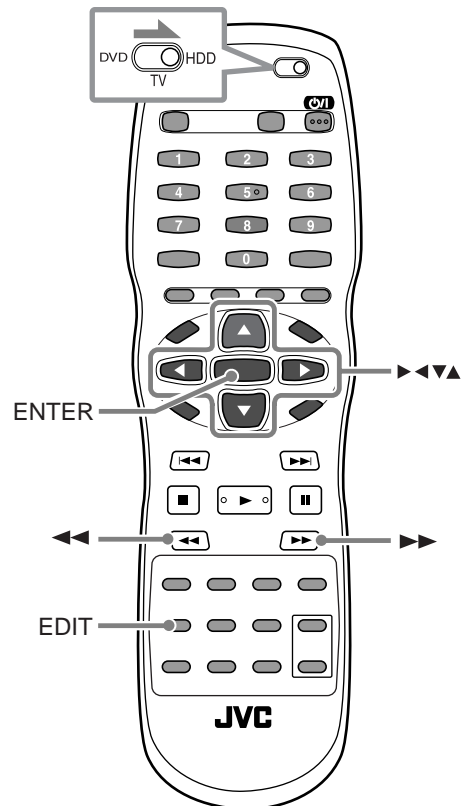

To create a play list

1 Show the EDIT screen.

Press **EDIT**.

2 Enter the PLAY LIST/CREATE screen.

Press **▶/◀/▼/▲** to move **↔** to "CREATE" under "PLAY LIST," then press **ENTER**.

- The PLAY LIST/CREATE screen appears.



3 Select a programme which includes a scene you want to list up in a play list.

Press **▶/◀/▼/▲** to move **↔** to a thumbnail you want, then press **ENTER**.

- The play list screen appears, and selected programme starts playing in the viewing window.
- You can use **▶▶**, **◀◀**, **▶**, and **⏏** to search for your favourite scene.

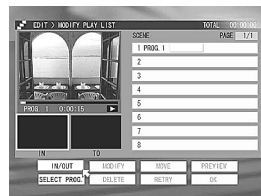

4 Select the start and end points of the scene you want.

- Make sure that **↔** is pointing "IN/OUT."
- Press **ENTER** where you want to start the scene.
 - The beginning of the scene (thumbnail) appears in the "IN" window below the viewing window.
 - The time information of the start scene appear in the play list on the right of the screen.
- Press **ENTER** again where you want to end the scene.
 - The end of the scene (thumbnail) appears in the "OUT" window below the viewing window.
 - The time information of the end of the scene appear in the play list.
 - You can use **▶▶**, **◀◀**, **▶**, and **⏏** to search for the end point.

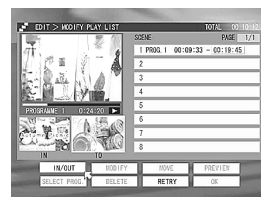

NOTE

You can use seven functions (except "MOVE") listed at the bottom of the screen after you have selected the first one scene. When the second scene is selected, "MOVE" become usable.

5 Select other scenes you want.

- To select another scene from the same programme: Repeat step **4**.
- To select another scene from a different programme:
 - Press **▶/◀/▼/▲** to move **↔** to "SELECT PROG.," then press **ENTER**. The PLAY LIST/CREATE screen appears again.
 - Press **▶/◀/▼/▲** to move **↔** to a thumbnail, then press **ENTER**.
 - Repeat step **4**.
- To delete a scene:
 - Press **▶/◀/▼/▲** to move **↔** to "DELETE," then press **ENTER**.
 - Press **▼/▲** to move **↔** to a scene number you want to delete in the right list on the screen, then press **ENTER**.
 - To restore the deleted scene soon after you have just deleted it, press **▶/◀/▼/▲** to move **↔** to "RETRY," then press **ENTER**.
- To move a scene:
 - Press **▶/◀/▼/▲** to move **↔** to "MOVE," then press **ENTER**.
 - Press **▼/▲** to move **↔** to a scene number you want to move from in the right list on the screen, then press **ENTER**.
 - Press **▼/▲** to move **↔** to the position you want to move to in the right list on the screen, then press **ENTER**. The listed scenes are automatically renumbered.
 - To cancel the movement soon after you have just moved it, press **▶/◀/▼/▲** to move **↔** to "RETRY," then press **ENTER**.
- To modify a scene:
 - Press **▶/◀/▼/▲** to move **↔** to "MODIFY," then press **ENTER**.
 - Press **▶/◀/▼/▲** to move **↔** to either of the start time or the end time of a scene you want to modify in the right list on the screen, then press **ENTER**. Playback start from that point. (If playback does not start, press **▶**, **▶▶**, or **◀◀**.)
 - Press **ENTER** again at a scene which you want to use as a new start or end point.
 - If you want to change both the start and end points, repeat step **2** and **3** above.
 - To cancel the last change soon after you have just made it, press **▶/◀/▼/▲** to move **↔** to "RETRY," then press **ENTER**.
- To review the entire play list:
 - Press **▶/◀/▼/▲** to move **↔** to "REVIEW," then press **ENTER**. Playback starts in the viewing window.
 - To stop review, press **■** (CLEAR).

6 Finish making (or modifying) a play list

Press ►/◄/▼/▲ to move  to "OK," then press **ENTER**.

- The play list screen disappears, and the confirmation screen appears.



7 Finish the procedure.

Press **ENTER** after making sure that  is pointing at "EXIT."

- **To modify the play list**, press ◀ to move  to "MODIFY," then press **ENTER**. (Then follow step 2 of "To modify a play list" below.)

To modify a play list

1 Show the main modification screen.

- 1 Press **EDIT**.
- 2 Press ►/◄/▼/▲ to move  to "MODIFY" under "PLAY LIST," then press **ENTER**.
- 3 Press ►/◄/▼/▲ to move  to a thumbnail you want to modify, then press **ENTER**.



2 Select the item you want to modify.

Press ►/◄/▼/▲ to move  to an item on the screen, then press **ENTER**.

INDEX	Select to change the thumbnail.
CATEGORY	Select to change the category.
TITLE	Select to change the title.
SCENE	Select to modify the scenes.

3 Make modifications.

- **To change the thumbnail:** Refer to step 4 of "To use your favourite scene for the thumbnail" on page 35.
 - ➔ Press **EDIT** to finish.
- **To change the category:** Refer to step 3 of "To change the category (or to categorize a programme)" on page 35.
 - ➔ Press **EDIT** to finish.
- **To change the title:** Refer to steps 3 and 4 of "To change (or newly assign) the title" on page 36.
 - ➔ Press **EDIT** to finish.
- **To change the scene:** Refer to steps 5 (To modify a scene) to 7 of "To create a play list" on page 38 and on this page.

To delete a play list

1 Show the PLAY LIST/DELETE screen.

- 1 Press **EDIT**.
- 2 Press ►/◄/▼/▲ to move  to "DELETE" under "PLAY LIST," then press **ENTER**.
 - PLAY LIST/DELETE screen appears.

2 Select an unnecessary play list.

Press ►/◄/▼/▲ to move  to a thumbnail you want to delete, then press **ENTER**.

- The confirmation screen appears.



3 Confirm the deletion.

Press ◀ to move  to "DELETE," then press **ENTER**.

- **To cancel the deletion**, press ► to move  to "CANCEL," then press **ENTER**. (You can select a thumbnail again.)

4 Finish the procedure.

Press **EDIT**.

This unit allows you to preset up to 16 recording timer settings using either one of the following:

- VIDEO PLUS+® Timer programming
- Express Timer programming

VIDEO PLUS+® Timer programming

With the VIDEO PLUS+® system, timer programming is greatly simplified because each TV programme has a respective code number which this unit is able to recognize.

- Make sure that the clock built in this unit is set properly.
- Turn on the TV and select an appropriate input (AV) mode.
- To record a satellite broadcast, install the supplied satellite controller on page 17.
- When using the buttons on the unit, make sure that the HDD lamp on the unit is lit. If not, press **DVD/HDD** so that the HDD lamp lights.
- When using the remote control, slide the **DVD/TV/HDD** selector to the right (**HDD**), then press **ENTER**.

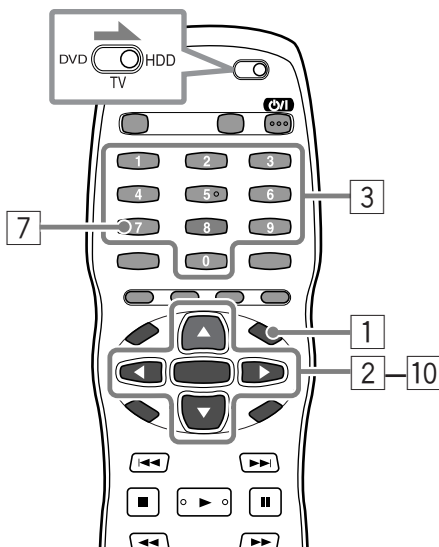
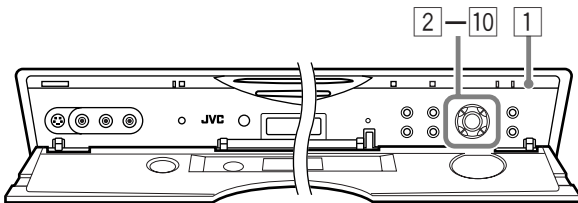

To go back to the previous screen while programming, press **RETURN**.

1 Show the PROGRAM screen.

Press **HDD PROGRAMME**.

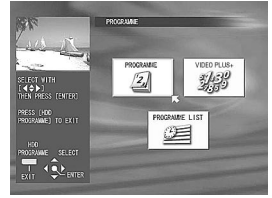

2 Select the VIDEO PLUS+® Timer programming.

Press **▶/◀/▼/▲** to move **⏏** to "VIDEO PLUS+," then press **ENTER**.

NOTE

If "PROGRAMME FULL DELETE UNWANTED TIMER PROGRAMME" appears on the TV, erase unwanted programmings from memory (see page 45).

3 Enter the PLUSCODE number.

- 1 Press **▶/◀/▼/▲** to move **⏏** to a desired number, then press **ENTER**.
- 2 Repeat step 1 until you enter the entire PLUSCODE number.



NOTE

You can also use **number** buttons to enter the PLUSCODE number.

- To make an incorrect number, press **▶/◀/▼/▲** to move **⏏** to "DELETE," then press **ENTER**. Each time you press the button, the last entry is cancelled.
- To delete all entered numbers at a time, press **▶/◀/▼/▲** to move **⏏** to "DELETE ALL," then press **ENTER**.

4 Confirm the PLUSCODE number.

Press **▼** to move **⏏** to "CONFIRM," then press **ENTER**.

- The PLUSCODE number you have entered and its contents of the timer programming are shown on the screen.



NOTES

- If the number you entered is invalid, "PLUSCODE NO. ERROR CONFIRM PLUSCODE NO. THEN RETRY" appears on the TV. Enter a valid PLUSCODE number.
- If "...SET GUIDE PROG THEN RETRY" appears on the TV, set Guide Program numbers (see page 69) manually.

5 Check the contents of the new timer programming.

To erase this setting, press **HDD PROGRAMME**.

IMPORTANT

Make sure the programme position number you wish to record is displayed; if not, set the Guide Program number correctly (see page 69).

6 Select the recording speed.

- Press ▼ or ▲ to move  to "REC MODE", then press **ENTER**.
- Press ▼ or ▲ to select the desired mode, then press **ENTER**.

7 Set the Weekly/Daily Timer.

- Press ▼ or ▲ to move  to "WEEKLY/DAILY," then press **ENTER**.
- Press ▼ or ▲ to select the desired mode, then press **ENTER**.

NOTE

For details on each mode, see page 44.

8 Set the PDC mode.

- Press ▼ or ▲ to move  to "VPS/PDC," then press **ENTER**.
- Press ▼ or ▲ to select "ON" or "OFF."

NOTES

- You can also use **VPS/PDC** button to turn the PDC setting "ON" and "OFF." PDC works for a timer recording only when the unit is turned off.
- You cannot set "PDC" to "ON" for a satellite broadcast programme. If you want to use PDC for a satellite programme recording, use Automatic Satellite Recording (see page 46).
- VPS (Video Programme System) recording is not currently available in the U.K. and not possible with this unit.



9 Select and set other options as required.

To modify a title of the TV programme:

- Press ▼ or ▲ to move  to "TITLE," then press **ENTER**.
- Enter the title by referring to "To change (or newly assign) the title" on page 36.





To modify the category of the TV programme:

- Press ▼ or ▲ to move  to "CATEGORY," then press **ENTER**.
- Press ► / ◀ / ▼ / ▲ to move  to a new category, then press **ENTER**.



10 Finish the timer programming.



- Press ▼ to move  to "OK," then press **ENTER**.
 - Press **ENTER** again after making sure that  is pointing at "EXIT."
- The recording timer is automatically activated.
 - For a satellite programme, leave the satellite receiver turned on.

To continue timer programming for other programmes, press ◀ to move the arrow to "CONTINUE," then press **ENTER**.

NOTES

- If "...PROGRAMME OVERLAPPED..." appears in step 10, erase the unnecessary programme by referring to page 45.
- About 1 minute before a timer recording starts, the lamp next to the ● (record) button on the unit lights to inform you that the HDD is now ready for the timer recording.
- You cannot make a timer programming for a TV programme with a PLUSCODE number starting with "0."

To stop while recording in progress

- Press **■ (CLEAR)**.
 - The confirmation screen appears.
- Press ◀ to move  to "CANCEL," then press **ENTER**.
 - To continue recording, simply press **ENTER** (with  pointing at "CONTINUE").
 - You cannot stop the recording if a timer recording starts while the unit is turned off.

Express Timer programming

If you do not know the PLUSCODE number for a TV programme you want to record, use the following procedure to set the timer programmings.

- Make sure that the clock built in this unit is set properly.
- Turn on the TV and select an appropriate input (AV) mode.
- When using the buttons on the unit, make sure that the HDD lamp on the unit is lit. If not, press **DVD/HDD** so that the HDD lamp lights.
- When using the remote control, slide the **DVD/TV/HDD** selector to the right (**HDD**), then press **ENTER**.

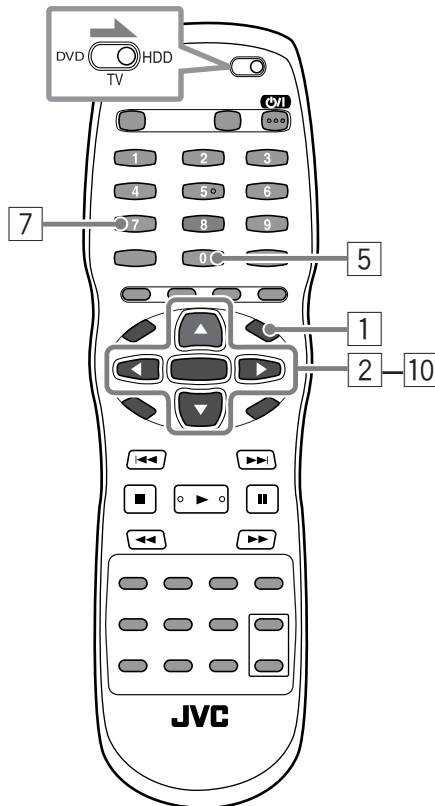
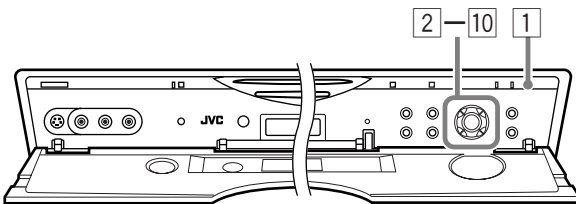

To go back to the previous screen while programming, press **RETURN**.

1 Show the PROGRAM screen.

Press **HDD PROGRAMME**.

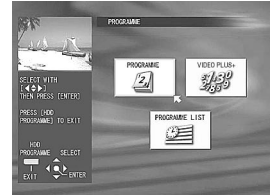

2 Select the Express Timer programming.

- ① Make sure that is pointing at "PROGRAMME."
- ② Press **ENTER**.

NOTE

If "PROGRAMME FULL DELETE UNWANTED TIMER PROGRAMME" appears on the TV, erase unwanted programmings from memory (see page 45).

3 Set the date.

Press **▶** / **<** / **▼** / **▲** to move to the desired date, then press **ENTER**.

4 Set the start time and stop time of the programme.

- ① Press **▼** or **▲** to move to "START," then press **ENTER**.
- ② Press **▼** or **▲** to select the desired time, then press **ENTER**.
- ③ Press **▼** or **▲** to move to "STOP," then press **ENTER**.
- ④ Press **▼** or **▲** to select the desired time, then press **ENTER**.

5 Select the programme position number.

- ① Press **▼** or **▲** to move to "TV PROG," then press **ENTER**.
 - If you want to timer-record a satellite broadcast, press the **number** button "0" to change "TV PROG" to "SAT" before pressing **ENTER**.
- ② Press **▼** or **▲** to select the desired programme position number, then press **ENTER**.
- ③ Press **▼** to move the cursor to "CONFIRM," then press **ENTER**.

6 Select the recording speed.

- ① Press **▼** or **▲** to move to "REC MODE," then press **ENTER**.
- ② Press **▼** or **▲** to select the desired mode, then press **ENTER**.

7 Set the Weekly/Daily Timer.

- 1 Press ▼ or ▲ to move  to "WEEKLY/DAILY," then press **ENTER**.
- 2 Press ▼ or ▲ to select the desired mode, then press **ENTER**.

NOTE

For details on each mode, see page 44.

8 Set the PDC mode.

- 1 Press ▼ or ▲ to move  to "VPS/PDC," then press **ENTER**.
- 2 Press ▼ or ▲ to select "ON" or "OFF."

NOTES

- You can also use **VPS/PDC** button to turn the PDC setting "ON" and "OFF." PDC works for a timer recording only when the unit is turned off.
- You cannot set "PDC" to "ON" for a satellite broadcast programme. If you want to use PDC for a satellite programme recording, use Automatic Satellite Recording (see page 46).
- VPS (Video Programme System) recording is not currently available in the U.K. and not possible with this unit.



9 Select and set other options as required.

To modify a title of the TV programme:

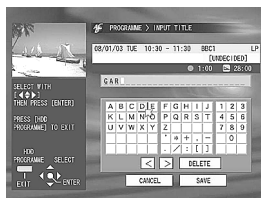
- 1 Press ▼ or ▲ to move  to "TITLE," then press **ENTER**.
- 2 Enter the title by referring to "To change (or newly assign) the title" on page 36.





To modify the category of the TV programme:

- 1 Press ▼ or ▲ to move  to "CATEGORY," then press **ENTER**.
- 2 Press ► / ◀ / ▼ / ▲ to move  to a new category, then press **ENTER**.



10 Finish the timer programming.

- 1 Press ▼ to move  to "OK," then press **ENTER**.
 - The confirmation screen appears.
- 2 Press **ENTER** again after making sure that  is pointing at "EXIT."
 - The recording timer is automatically activated.



To continue timer programming for other programmes, press ◀ to move the arrow to "CONTINUE," then press **ENTER**.

NOTES

- If "...PROGRAMME OVERLAPPED..." appears on the TV screen, erase the unnecessary programme by referring to page 45.
- For a satellite programme, leave the satellite receiver turned on.

When you confirm, cancel, or change programme, see page 45.

To stop while recording in progress

1. Press **■ (CLEAR)**.
 - The confirmation screen appears.
2. Press ◀ to move  to "CANCEL," then press **ENTER**.
 - To continue recording, simply press **ENTER** (with  pointing at "CONTINUE").
 - You cannot stop the recording if a timer recording starts while the unit is turned off.

Weekly/Daily Timer

You can select the following modes for Weekly/Daily Timer—**ONCE**, **WEEKLY (OVERWRITE)** or **(a) certain day(s)**.

- **ONCE** (Once Timer recording)

Select to perform the timer recording only once with this setting.

- **WEEKLY (OVERWRITE)** (Weekly Timer recording/ Weekly overwrite)

Select to record a weekly programme. A recorded programme is automatically overwritten by the same series of the programme of the next week.

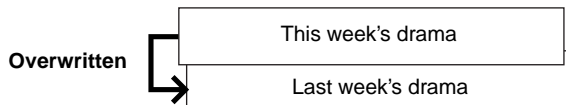

- **MON-SUN (FOR A WEEK)/ MON-SAT (FOR A WEEK)/ MON-FRI (FOR A WEEK)** (Weekly Timer recording/Weekly overwrite)

Select to record a weekly programme. A recorded programme is automatically overwritten by the same series of the programme broadcast on the same day of the next week.

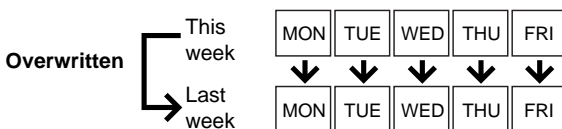

- **MON-SUN (OVERWRITE)/ MON-SAT (OVERWRITE)/ MON-FRI (OVERWRITE)** (Daily Timer recording/Daily overwrite)

Select to record a daily programme. A programme recorded one day is automatically overwritten by the same series of the programme broadcast on the next day.

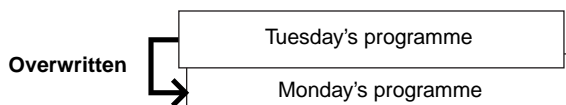
**NOTE**

When you select a mode other than **ONCE**, be careful not to delete important recordings as they are always overwritten.

Programme Delivery Control (PDC) Recording

Now available from some TV stations, Programme Delivery Control (PDC) is a service designed to assure safe, accurate timer recording. With this system, special code signals are transmitted together with the audio/video signals. These code signals control your video recorder (for this unit, the HDD deck) and have precedence over the advertised times which you may have preset into the timer. This means that your recorder will start and stop recording when the preset TV programmes actually start and end—even if the broadcast time of a preset TV programme is changed from what has been advertised.

PDC is available nationally on BBC1, BBC2, Channel 4 and Channel 5 (except the cases that the programmes are broadcast through a few small relay transmitters). Channel 3 operates a PDC service in some areas. All channels intend to offer this service in due course. Check your TV programme listing guide for latest information.

If the TV station you intend to record does not offer a PDC service, your recorder will not start recording if PDC has been turned "ON." Be sure to turn "OFF" PDC in this case.

NOTES

- When you use Express Timer programming, set the start time exactly as advertised in the TV listing.
- Now most of the satellite stations and the cable systems also offer the PDC service. However, with this unit, PDC recording of a satellite programme is only possible using Automatic Satellite Recording (if your satellite receiver can detect the PDC signals). See page 46.
- PDC works for a timer recording only when the unit is turned off.

Modifying timer programmings

You can confirm, erase, or modify the preset timer programmings easily.

- Make sure that the clock built in this unit is set properly.
- Turn on the TV and select an appropriate input (AV) mode.
- When using the buttons on the unit, make sure that the HDD lamp on the unit is lit. If not, press **DVD/HDD** so that the HDD lamp lights.
- When using the remote control, slide the **DVD/TV/HDD** selector to the right (**HDD**), then press **ENTER**.

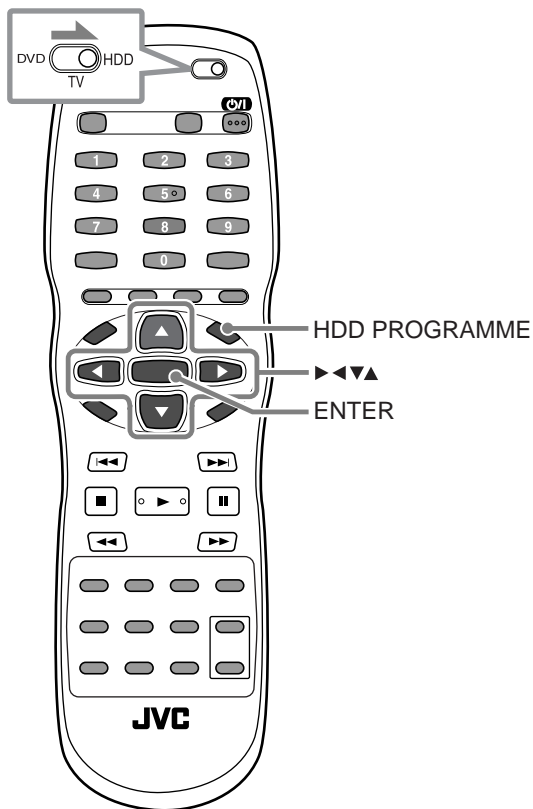
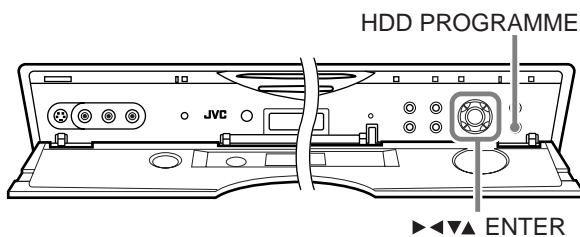

1 Show the PROGRAMME LIST screen.

- ① Press **HDD PROGRAMME**.
- ② Press **▶/◀/▼/▲** to move  to "PROGRAMME LIST," then press **ENTER**.

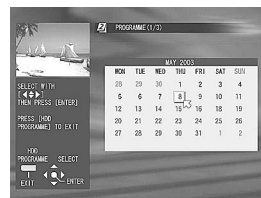

2 Select a date for which the timer programming you want is listed.

Press **▶/◀/▼/▲** to move  to the desired date, then press **ENTER**.

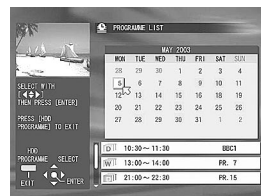

3 Select the timer programming you want to confirm, erase, or modify.

Press **▼** or **▲** to move  to select one of the timer programmings listed for the date, then press **ENTER**.



4 Confirm, erase, or change the timer programming.

To cancel the programming, press **◀** to move  to "CANCEL," then press **ENTER**.

➔ Press **HDD PROGRAM** to finish.

To confirm or change the contents of the programming

- ① Press **ENTER** after making sure that  is pointing at "MODIFY."
- The calendar appears again.
- ② Press **ENTER** again after making sure that the selected date is correct.
- ③ Confirm the content, or modify it by referring steps 4 to 10 of "Express Timer programming" on pages 42 and 43.

Automatic Satellite Recording

This function allows you to automatically record a satellite programme using the timer equipped for the satellite receiver connected to the L-2 IN connector on the rear.

When the signals come into the unit from the satellite receiver, the unit automatically turns on and starts recording.

- When the satellite receiver is turned off by its timer, this unit also turns off automatically (into standby mode).

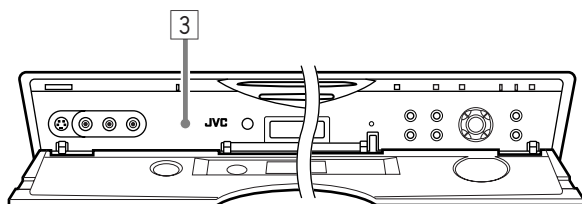

ATTENTIONS

- Be sure not to turn on the satellite receiver before Automatic Satellite Recording start recording; otherwise, this unit will start recording when you turn on the satellite receiver manually.
- If you have connected any external component other than a satellite receiver to the L-2 IN connector, activating Automatic Satellite Recording will start recording automatically when the external component is turned on.
- While Automatic Satellite Recording is activated, recording timer is temporarily deactivated. When Automatic Satellite Recording is over, recording timer is activated again.

Before performing the following steps:

- Set the timer on the satellite receiver correctly.
- When using the remote control, slide the DVD/TV/HDD selector to the right (HDD), then press ENTER.

1 Set the timer equipped for the satellite receiver correctly.

- For timer setting of the satellite receiver, refer to the instruction manual supplied for the satellite receiver.

2 Select the recording speed.

Press **REMAIN/REC MODE** on the remote control repeatedly until the recording speed you want is selected (see page 24).

3 Activate Automatic Satellite Recording.

Press and hold **SAT** (timer) for about 2 seconds so that the button itself illuminates (in orange).

- The unit automatically enters standby mode.

To deactivate Automatic Satellite Recording, press **SAT** (timer).

To cancel Automatic Satellite Recording while recording is being made, press **⏻** (STANDBY/ON).

NOTES

- The lamp next to the ● (record) button lights and the **SAT** (timer) button starts flashing while Automatic Satellite Recording is in progress.
- Some satellite receivers emit signals even if the power is off. Automatic Satellite Recording is not possible with these satellite receivers. (In this case, The lamp to the ● (record) button lights and the **SAT** (timer) button starts flashing when you activate Automatic Satellite Recording.)
- When using Automatic Satellite Recording, you cannot set a different recording speed for each programme. To do it, use Automatic Satellite Recording separately for each programme.
- With some satellite receivers connected, this unit may not be able to be synchronized to start and stop recording as exactly as set by the timer equipped with these satellite receivers.
- If you activate Automatic Satellite Recording while the satellite receiver is turned on, this unit does not start Automatic Satellite Recording.
- You can also record a programme from your cable system in the same way if the system has a timer.
- Just Clock (see page 69) does not work while Automatic Satellite Recording is being activated.

Playing back discs

In the DVD operation sections, the following marks are used to indicate disc availability:

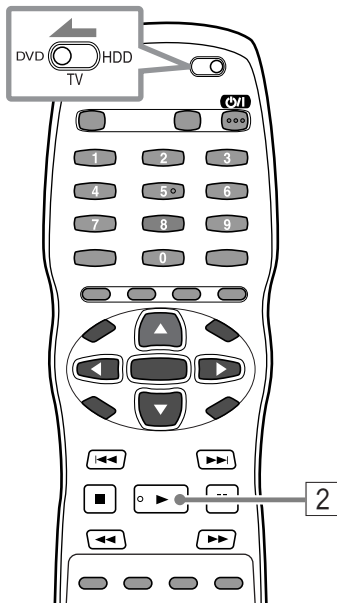
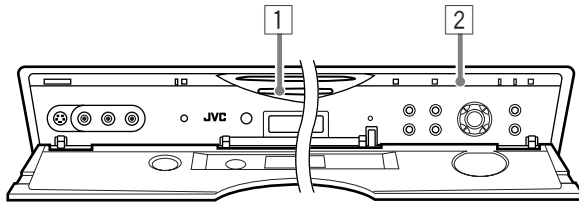

1 Insert a disc in the disc slot.

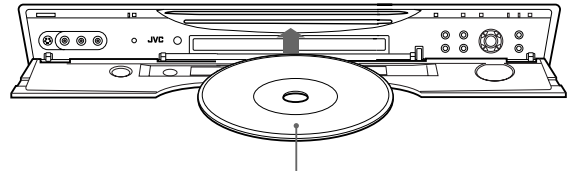

With the label side up

To insert an 8-cm disc, insert it into the centre of the disc slot.

- When the disc is detected, the respective disc type indicator lights in the display window (and playback starts automatically for some discs).
- If you insert a wrong disc, press ▲ on the unit or EJECT on the remote control to eject the disc.

NOTES

- If a disc has been already loaded, you cannot insert another disc.
- When inserting a double-sided disc, make sure that insert it with the surface you want to play facing down.
- If you insert a disc with the unit turned off, the unit comes on with the DVD player selected for the playback source.
- If the unit has been turned on with the HDD deck selected, press DVD/HDD so that the DVD lamp lights.

2 Start playback.

Press ► (SELECT).

- The digital disc audio format indicator lights in the display window, and the unit starts playback from the beginning.
- While playing an MP3 disc or a JPEG disc, the associated CONTROL screen appears on the TV. For details, see pages 61 and 64.

Before performing any operations:

- Turn on the TV and select an appropriate input (AV) mode.
- During the following periods, the unit will not accept any button operation:
 - If the unit is plugged in: For about 30 seconds. The illumination lamp on the unit flashes during this period. **During this period, disc insertion will not be accepted either.**
 - If the unit is turned on with the HDD deck selected: For about 20 seconds. During this period, the opening screen appears.

About invalid operation icon

When the unit does not accept an operation, ⊗ appears on the TV.

- Operations are occasionally unacceptable even if ⊗ is not displayed.

If a menu is shown on the TV screen

When inserting a DVD Video, SVCD or VCD, the menu recorded in the disc will be shown on the TV. Using the menu, you can select a desired item to play.

For DVD Video

Press ► / ◀ / ▼ / ▲ to move ⏏ to select an item you want, then press ENTER.

- The unit starts playing back the selected item.

For SVCD/VCD

Press the number buttons to select an item you want.

- The unit starts playing back the selected item.

NOTES

- If you operate the HDD deck during playback, playback stops automatically.
- Do not insert an unplayable disc (see page 4).

About PBC (Playback Control)

Some SVCDs/VCDs are equipped with PBC. PBC allows you to enjoy menu-driven operations and high-resolution still pictures which have a resolution four times greater than moving pictures.

- **To play an SVCD/VCD without activating PBC**, press ■ (CLEAR) to stop playback, then press the **number** button(s). Playback starts with the selected track.
- **To activate PBC again**, press **TOP MENU** or **MENU**.

To check the playback status



You can see the current selection number (the title/chapter number for DVD Video or track number for SVCD/VCD/CD), time information (the track or chapter time while stopped, or elapsed track or chapter time during playback) and the transport status (stop, playback, pause, etc.) on the TV.

Press **ON SCREEN**.

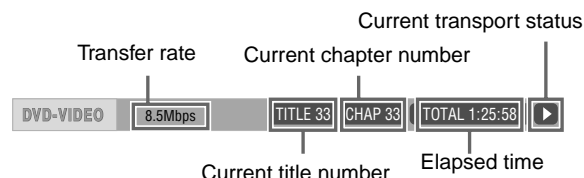

Example: for DVD Video

Note that pressing **ON SCREEN** again brings up the menu bar under the status bar, from which you can operate various functions. See page 59 for details about the menu bar.

To turn off the status bar

Press **ON SCREEN** repeatedly until the status bar goes off.

To stop playback completely

Press ■ (CLEAR).

To stop playback temporarily (Pause/Still Picture)

Press II.

To resume playback, press ▶ (SELECT).

To eject the disc

Press ▲ on the unit or **EJECT** on the remote control.

- If you press ▲ during playback, the unit stops playback and the disc is ejected.
- You can eject the disc while the unit is turned off.

NOTE

After ejecting a disc, take it off from the loading slot by hand. Do not leave it as it is.

About On-screen guide icons

You may see the following icons displayed over the picture.

- : Appears at the beginning of a scene recorded with multi-angles (see page 60).
- : Appears at the beginning of a scene recorded with multi-audio languages (see page 56).
- : Appears at the beginning of a scene recorded with multi-subtitle languages (see page 56).
- : Appears at the beginning of playback.
- : Appears when you stop playback temporarily.
- : Appears when you start forward search (see page 49).
- : Appears when you start reverse search (see page 49).
- : Appears when you start forward slow motion (see page 50).
- : Appears when you start reverse slow motion (see page 50).

About Screen Saver

The TV screen may have an image burned on it if a static image is displayed for a long time. To prevent this, the unit automatically activates Screen Saver if a static picture or menu is displayed for over 5 minutes. While Screen Saver is working, the TV screen dims. Pressing any button will cancel Screen Saver temporarily (see also page 77).

NOTE

Screen Saver does not work while operating the HDD deck.

Resuming playback



The unit can memorize the position on a disc where you have stopped playback, and resume playback from that position later.

You can select either "ON" or "DISC RESUME" for resume function.

- You can select your desired option using the menu (see page 79).

When "RESUME" is set to "ON" (initial setting)

When you press ■ (CLEAR) ("RESUME STOP" appears on the TV) or try to operate the HDD deck, the unit stops playback and memorizes the interrupted position.

The memory of the interrupted position is cleared when you turn off the unit or when you eject the disc.

- Next time you press ► (SELECT), playback starts from the interrupted position of the disc ("RESUME PLAY" appears on the TV).
- **To play back from the beginning**, press ■ (CLEAR), then press ► (SELECT).

When "RESUME" is set to "DISC RESUME"

When you press ■ (CLEAR) ("RESUME STOP" appears on the TV) or try to operate the HDD deck, the unit stops playback and memorizes the interrupted position.

The memory of the interrupted position is not cleared even if you eject the disc or turn off the unit.

- When you insert a disc for which the unit has stored an interrupted position ("RESUME STOP" appears on the TV). Then when you press ► (SELECT), playback starts from the interrupted position ("RESUME PLAY" appears on the TV).
- **To play back from the beginning**, press ■ (CLEAR) after inserting a disc, then press ► (SELECT) to start playback.

NOTE

The unit memorizes interrupted positions for the 30 discs played recently. Storing an interrupted position for a 31st disc will erase the interrupted position stored first.

To clear the memory

Press ■ (CLEAR) while the disc is not playing.

To cancel the resume function

Select "OFF" for "RESUME" (see page 79).

NOTES

- If you change the "RESUME" setting from "DISC RESUME" to "OFF" or "ON," the unit cannot recall the interrupted position stored for the discs; however, the stored interrupted positions are never erased due to this setting change.
- If you stop playback of a disc with an interrupted position stored in memory, this new interrupted position is stored for the disc (the previous interrupted position is overwritten in memory).
- For a double-sided DVD Video, the unit stores an interrupted position separately for each side. To start playing such a disc, make sure of inserting it with the desired side down.
- When the unit memorizes an interrupted point for a disc, it also memorizes Audio, Subtitle and Angle settings. (See pages 56 and 60.)
- The unit may not resume playback exactly from the interrupted point of a disc. In the case of an SVCD/VCD disc with PBC, the unit may start playing it back from a point slightly different point (either backward or forward).

Various speed playback

Advancing or reversing playback rapidly while monitoring



During playback, press ►► or ◀◀ repeatedly on the remote control.

- Each time you press ►► or ◀◀, the playback speed changes as follows:

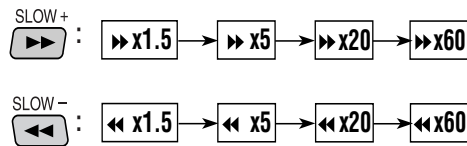

To return to the normal speed, press ► (SELECT).

NOTES

- You can use x1.5 quick playback with sound only while playing a DVD Video or VCD. You can listen to the sounds and also see the subtitle (for DVD) on the TV. (Sound quality, level, or tone may be changed for some discs.)
- During x1.5 quick playback with sound on a DVD Video or VCD, the digital sound is output in stereo linear PCM format through the DVD DIGITAL OUT connectors.
- Rapid playback at 1.5 times normal speed is also possible on the other types of disc; however, the sound cannot be heard (for CDs, the sound will be heard intermittently).
- If you press and hold ►► or ◀◀ either on the unit or on the remote control, playback is advanced or reversed at 5 times normal speed.

Advancing a still picture frame by frame—Frame-by-Frame Playback



1. Press **II** during play.
Still picture appears.
2. Press **▶▶** repeatedly.
 - Each time you press the button, the still picture advances to the next frame.

To return to the normal playback, press **▶** (SELECT).

NOTE

You cannot reverse a still picture frame by frame (if you press **◀◀**).

Playing back in slow motion—Slow Motion



You can select from 1/32 times, 1/16 times, 1/4 times and 1/2 times normal speed.

Playing in slow motion—Slow Motion

You can select the slow motion speed.

- You cannot hear playback sounds during Slow Motion.

- 1 Press **II** to freeze the picture on the TV.
- 2 Press and hold **SLOW +** (**▶▶**) or **SLOW -** (**◀◀**) for about 2 seconds to start slow motion playback.
 - Each time you press the button, playback speed changes as follows:

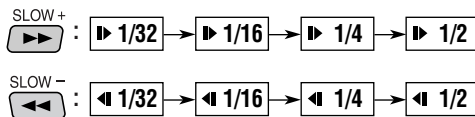

To return to the normal playback, press **▶** (SELECT).

NOTES

- During slow motion playback, the sound will be muted.
- Reverse slow motion playback is not possible for an SVCD and VCD.

Going back to a previous scene quickly and play it back—One Touch Replay



While playing, press **↶**.

Disc play goes back to a scene of about 10 second before, and start replay from it.

NOTES

- This function works only within the same title, though it works between chapters.
- This function may not work with some DVD Videos.

Locating the beginning of a scene or song



- For DVD Video: During playback
- For SVCD/VCD: During playback without PBC
- For CD/MP3: During playback or while in stop mode
- For JPEG: While the JPEG CONTROL screen is shown

To skip forward, press **▶▶▶**.

To skip backward, press **◀◀◀**.

When using the remote control, you can also use the number buttons.

- For DVD Video/CD/MP3: During playback or while in stop mode
- For SVCD/VCD: During playback without PBC or while in stop mode
- For JPEG: While the JPEG CONTROL screen is shown

Press the number buttons to specify the number.

The unit starts playback from the beginning of the selection.

Examples:

To select 5: press 5.

To select 23: press 2, then 3.

To select 40: press 4, then 0.

NOTES

- You cannot specify a 3-digit number using the number buttons.
- Depending on the disc type and the playback status, what is specified differs:

Playback status	Disc type	What is specified
While stopped	DVD Video	Title
	SVCD/VCD/CD/MP3/JPEG	Track (File)
During playback	DVD Video	Chapter (or title, depending on the disc configuration)
	SVCD/VCD/CD/MP3/JPEG	Track (File)

- While playing a DVD Video/SVCD/VCD, if a menu is shown on the TV, the number buttons may be used for selecting an item in the menu.

Playing from a specific point

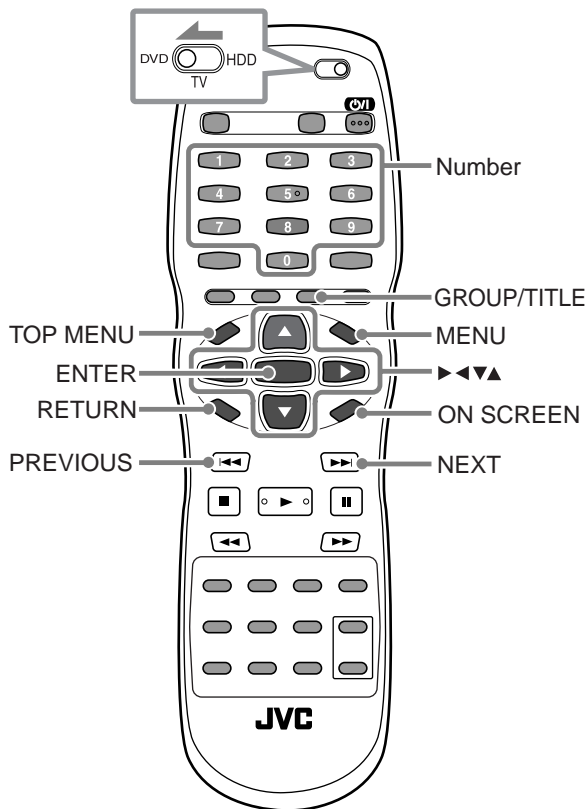
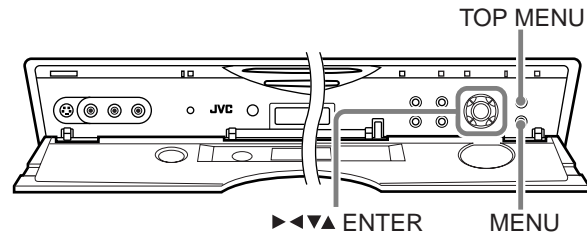

- When using the buttons on the unit, make sure that the DVD lamp on the unit is lit. If not, press **DVD/HDD** so that the DVD lamp lights.
- When using the remote control, slide the **DVD/TV/HDD** selector to the left (**DVD**), then press **ENTER**.

Locating a desired scene (item) from the disc menu

For DVD video:



DVD Video discs generally have their own menus which show the disc contents. These menus contain various items such as titles of movies, names of songs, or artist information, and display them on the TV. You can locate a desired scene using the DVD menu.

- See the instructions of each disc for its particular menus.
- 1 While a DVD Video disc is inserted, press TOP MENU or MENU.**
The menu appears on the TV.
 - The **MENU** button works only during playback or pause.
 - 2 Press ► / ◀ / ▼ / ▲ to select a desired item, then press ENTER.**
The unit starts playback of the selected item.

NOTES

- Some DVD Video discs may have different menus for **TOP MENU** and **MENU**.
- With some discs, you can select items by entering the corresponding number using the number buttons, which may cause the unit to automatically start playback.

For SVCD/VCD with PBC



Some SVCD/VCD discs support the PBC function. PBC is an abbreviation of "Playback Control." Some SVCD/VCD discs recorded with PBC have their own menus, such as a list of the songs of the disc. You can locate a specific scene by using the PBC menu.

- See the instructions of each disc for its particular menus.
- 1 Press ► or TOP MENU.**
Playback starts ("PBC" appears in the display window), then a disc menu appears on the TV.
 - If something like "NEXT" or "PREVIOUS" appears on the TV, pressing **NEXT** (►►) advances to the next page of the menu, and pressing **PREVIOUS** (◄◄) returns to the previous page of the menu.
 - 2 Press the number buttons to select the desired item.**
The unit starts playback of the selected item.
 - Examples: To select 5: press **5**.
 - To select 10: press **1**, then **0**.
 - To select 23: press **2**, then **3**.

To return to the menu, press **RETURN**.

Specifying a desired title



- 1 During playback, press GROUP/TITLE.**
The number below the TITLE indicator changes “--.”
- 2 Press the number button(s) to specify a title to play.**
The unit starts playback from the specified title.
 - Examples: To select 5: press **5**.
 - To select 23: press **2**, then **3**.
 - To select 40: press **4**, then **0**.

NOTE

This function may not work with some DVD Video discs.

Locating a desired position in the current title or track—Time Search



You can play a disc from the desired position by specifying the time from the beginning of the current title (for DVD Video) or the disc (for SVCD/VCD/CD).

- For DVD Video/CD: Any time
- For SVCD/VCD: Any time without PBC

- 1 Press ON SCREEN twice.**
The menu bar appears on the TV screen.
- 2 Press ► or ◀ to move to ⏮ to ⏭, then press ENTER.**
The pull-down menu for entering time appears.

Screen example for DVD Video

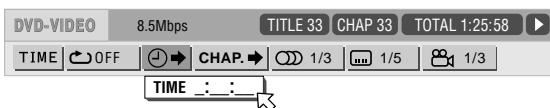

Screen example for Audio CD

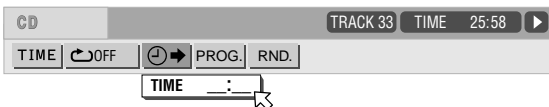

- 3 Press the number buttons (0 to 9) to enter the desired time.**
The specified time appears in the pull-down menu.
 - **Example (for DVD Video):**
To play back from 2(H):34(M):00(S)
Press 2, 3, then 4.

TIME 2:34:__

- **Example (for Audio CD):**
To play back from 23(M):40(S)
Press 2, 3, then 4.

TIME 23:4_

- You do not have to press **0** to enter the trailing zeros (for the last two digits in the first example, and the last digit for the second example).

To correct a mis-entry

Press ◀ repeatedly to move back to the digit where you entered a wrong number, and re-enter the correct one(s).

- 4 Press ENTER.**

The unit starts playback from the specified time.

To clear the menu bar

Press ON SCREEN.

NOTES

- Some DVD Video discs do not contain time information, and Time Search cannot be used.
- Time Search cannot be used during Program Play (see page 53).

Changing the playback order

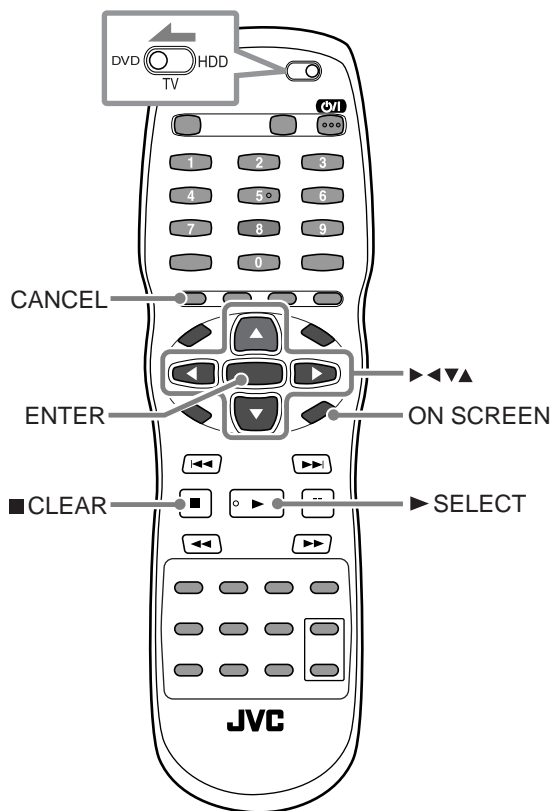

Playing in a specific order—Program Play



By programming tracks, you can play up to 99 tracks in any order. You may program the same track more than once.

- 1 Before starting playback, press **ON SCREEN** twice. The menu bar appears on the TV screen.
- 2 Press **▶** or **◀** to move to **PROG**, then press **ENTER**.

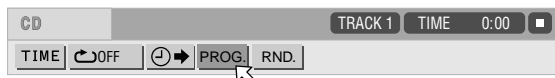

- 3 Press **ENTER**.
 - The PROGRAM table appears.
 - The PROGRAM indicator lights in the display window.

- 4 Press the number buttons to specify tracks in the desired order.
 - Examples: To select 5: press 5.
 - To select 10: press 1, then 0.
 - To select 23: press 2, then 3.

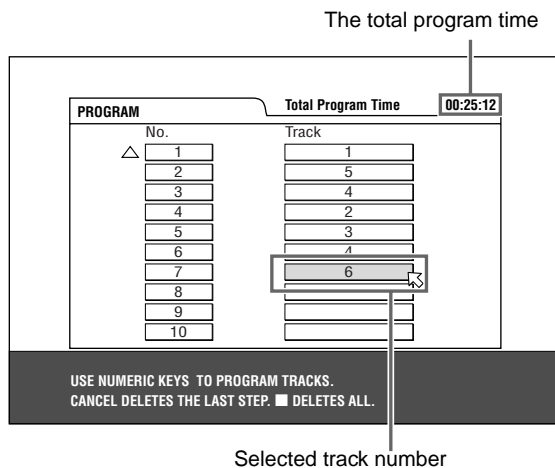

To correct the program

Press **▲** or **▼** to move to the track to be corrected, then press **CANCEL**. The track is erased and the subsequent programmed tracks move up in the PROGRAM table.

Pressing **■ (CLEAR)** clears all the programmed tracks.

- 5 Press **▶ (SELECT)** to start Program Play.

- With an Audio CD, the PROGRAM table remains on the TV during Program Play. (Pressing **ON SCREEN** clears the PROGRAM table, and brings up the status bar.)
- When all of the programmed tracks have finished playing, the unit stops and the PROGRAM table appears again. (Notice that the program is not erased).

To stop Program Play and to check the program contents

Press **■ (CLEAR)**.

Playback stops and the PROGRAM table is shown.

- If the PROGRAM table is not shown, you can bring up the table by performing steps 1 to 3.

To clear the program

While stopped and the PROGRAM table is shown, press **■ (CLEAR)**.

To exit from the program mode

After clearing the program, press **ON SCREEN**.

NOTES

- When the disc is ejected or the unit is turned off, the program is also cleared.
- During Program Play, you cannot edit the program contents.

Playing at random—Random Play



- 1 Before starting playback, press ON SCREEN twice.**
The menu bar appears on the TV.
- 2 Press ► or ◀ to move to RND., then press ENTER.**

Screen example for Audio CD

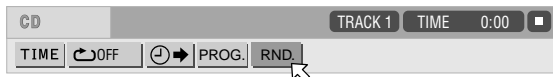

The RANDOM indicator lights in the display window, and the unit starts Random Play.

- With an SVCD/VCD disc, the menu bar automatically goes off.
- After playing all tracks of the disc, the unit stops playback and Random Play is cancelled.

To stop and cancel Random Play

Press ■ (CLEAR).

To clear the menu bar and status bar if still shown

Press ON SCREEN again.

Playing repeatedly—Repeat Play

To repeat the current track/file or all tracks/files



For DVD Video: During playback
For SVCD/VCD: During playback without PBC and while in stop mode

- 1 Press ON SCREEN twice.**
The menu bar appears on the TV.
- 2 Press ► or ◀ to move to OFF, then press ENTER.**
The pull-down menu for Repeat Play appears.
- 3 Press ▼ or ▲ to select an option you want, then press ENTER.**
 - For DVD Video:
 - CHAPTER: Current chapter repeat
 - TITLE: Current title repeat
 - A-B: A-B repeat (only selectable during play: see the following page.)
 - OFF: Repeat Play is cancelled
 - For SVCD/VCD/CD:
 - TRACK: Current track repeat
 - ALL: All track repeat
 - A-B: A-B repeat (only selectable during play: see the following page.)
 - OFF: Repeat Play is cancelled.

To start Repeat Play, press ► (SELECT) if necessary.

To stop repeat playback

Press ■ (CLEAR).

- When a DVD Video disc is loaded, the unit stops playback and cancels Repeat Play.
- When a disc of another type is loaded, the unit stops playback but does not cancel Repeat Play (except A-B repeat).

To cancel Repeat Play

Select "OFF" in step 3 above.

To clear the menu bar and status bar

Press ON SCREEN again.

NOTES

- When Repeat Play is selected, an appropriate repeat indicator also lights in the display window—◁ or ▷ 1, or A-B.

On-screen display	Display window
TITLE or ALL	▷
CHAPTER or TRACK	▷ 1
A-B	A-B
OFF	No indication

- For Repeat Play on MP3 and JPEG discs, see pages 63 and 65.

To repeat a desired part (A-B repeat playback)



For DVD Video/CD: During playback

For SVCD/VCD: During playback without PBC

- 1 Press ON SCREEN twice.**
The menu bar appears on the TV screen.
- 2 Press ► or ◀ to move to , then press ENTER.**
The pull-down menu for repeat mode selection appears.
- 3 Press ▼ or ▲ to select "A-B."**
- 4 Press ENTER at the beginning of the repeat part (point A).**
The pull down menu disappears.
The repeat icon shows .
- 5 Press ENTER at the end of the repeat part (point B).**
The repeat icon changes .
The unit locates "A" and starts repeat playback between "A" and "B."
The A-B indicator lights in the display window.

To quit A-B repeat playback

Press ► or ◀ to move to , and press ENTER.
The A-B repeat mode turns off, then normal playback continues.

- Pressing (CLEAR) to stop playback will also cancel A-B repeat.

NOTE

The A and B points must be set within the same title/track.

Changing the language, sound and scene angle

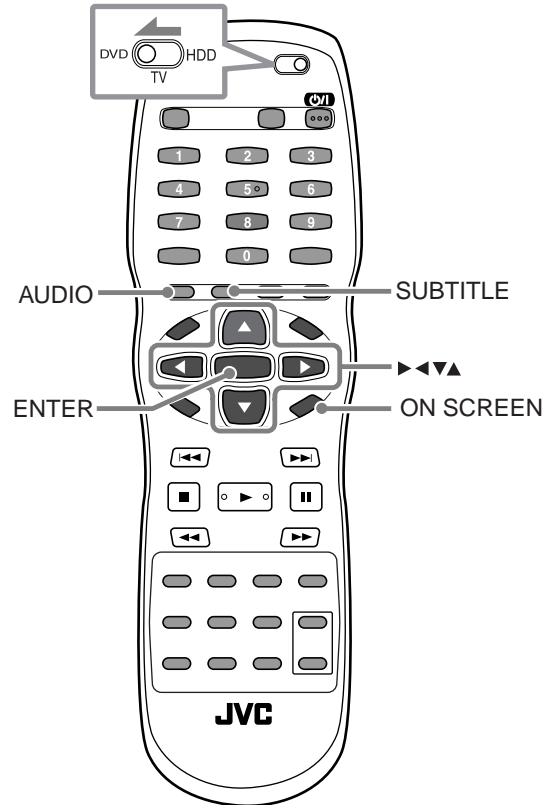

Selecting the subtitle language



Some DVD Video and SVCD discs contain more than one subtitle language. You can choose a desired one from them.

- At the beginning of the part if the subtitles are recorded, will appear on the TV (except when the “ON SCREEN GUIDE” is set to “OFF”—see page 79).

1 During playback, press SUBTITLE.

The subtitle selection window appears on the TV screen.

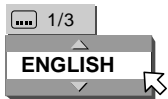

2 Press ▼ or ▲ (or SUBTITLE) to select the subtitle.

- Each time you press the button, the subtitle language changes.

3 Press ENTER.

Subtitles are displayed in the selected language. The subtitle selection window goes off.

NOTES

- An SVCD disc can have up to four subtitles. Pressing ▲/▼ or SUBTITLE selects subtitles regardless of whether the subtitles are recorded or not.
- The subtitle selection window will automatically disappear if you do not change the subtitle for several seconds.
- For DVD Video, the selected language may be abbreviated on the TV. See “Table of languages and their abbreviations” on page 92.

Changing the audio language or sound



The audio selection setting allows you to change the audio language of a movie, or to listen to karaoke with or without the vocal.

- At the beginning of the part where multiple audio tracks are recorded, will appear on the TV (except when the “ON SCREEN GUIDE” is set to “OFF”—see page 79).

1 During playback, press AUDIO.

The audio selection window appears on the TV.

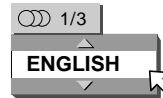

2 Press ▼ or ▲ (or AUDIO) to select the desired audio.

- Each time you press the button, the audio changes.

For DVD Video (example)



For SVCD

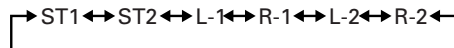

For VCD

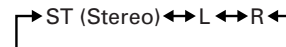

3 Press ENTER.

You can hear the selected audio.

The audio selection window goes off.

NOTES

- The audio selection window will automatically disappear if you do not change the audio for several seconds.
- For DVD Video, the selected language may be abbreviated on the TV. See “Table of languages and their abbreviations” on page 92.

To selecting a multi-angle view of DVD Video

You can enjoy a variety of scene angles if the DVD Video disc contains “multi-angle” parts, where multiple cameras were used to shoot the same scene from different angles.

- At the beginning of a “multi-angle” part, will appear on the TV (except when the “ON SCREEN GUIDE” is set to “OFF”—see page 79). (The ANGLE indicator remains lit in the display window while a chapter including multi-angle views is playing.)
- For detailed operations, see “Menu bar operations” on page 59.

Using sound effects and special picture playback

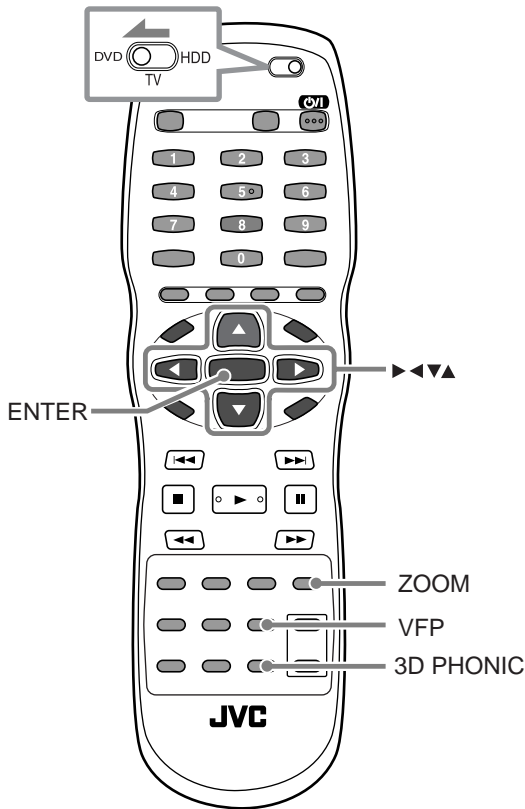

Simulating surround sound (3D PHONIC)



Using the 3D PHONIC function, you can get a simulated surround effect from your stereo system.

1 During playback, press 3D PHONIC.

The 3D PHONIC window appears on the TV.

2 Press ► or ◀ to select the desired mode.

- Each time you press the button, the 3D PHONIC mode changes as follows:

→ ACTION ↔ DRAMA ↔ THEATER ↔ NONE ←



Selected effect mode

• ACTION

Suitable for action movies and sports programs in which the sound source moves.

• DRAMA

Natural and warm sound. You can enjoy movies in a relaxed mood.

• THEATER

You can enjoy sound effects like in a theatre.

• NONE

To cancel 3D PHONIC.

3 Press ▼ or ▲ to adjust the effect level.

You can set the effect level from "1" to "5" separately for each mode.

The higher value enhances the effect.

To clear the 3D PHONIC window

Press 3D PHONIC again.

To cancel the effect

Select "NONE" in step 2 above

- Turning off the unit also cancels the effect.

NOTES

- The 3D PHONIC window disappears if no operation is made for about 10 seconds.
- 3D PHONIC works correctly only when playing back a Dolby Digital encoded DVD Video. However, if Dolby Digital does not contain the rear signal, you will not be able to achieve a correct 3D effect.
- 3D PHONIC does not affect output through the DIGITAL OUT connectors on the rear.
- While 3D PHONIC is activated, the "ANALOG DOWN MIX" setting (see page 78) is temporarily cancelled.

Adjusting the picture



Video Fine Processor (VFP) allows you to adjust the picture according to the type of software, picture tone or personal preferences.

Set the video type most suitable to the current software or the room conditions.

1 During playback, press VFP.

The VFP mode selection window appears on the TV screen.

2 Press ► or ◀ to select the desired preset.

- Each time you press the button, the VFP mode changes as follows.

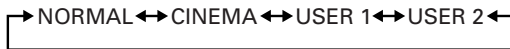

Selected preset

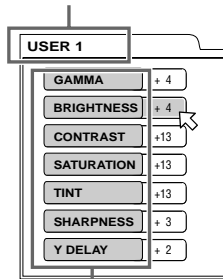

Parameter

- **NORMAL:** For watching TV in a general room.
- **CINEMA:** For watching a movie software in a room with suppressed light.
- **USER 1/USER 2:** You can adjust parameters that affect the picture character and store the settings as a user preset. See the next step.

3 To define a user setting (USER 1/USER 2), press ▼ or ▲ to select a parameter to edit from the following.

• GAMMA

Adjust this if the neutral colour is bright or dark. The brightness of dark and bright portion remains unchanged.

Available range: -4 (darkest) to +4 (brightest).

• BRIGHTNESS

Adjust this if the picture is bright or dark on the whole.

Available range: -16 (darkest) to +16 (brightest).

• CONTRAST

Adjust this if the far and near position is unnatural.

Available range: -16 to +16.

• SATURATION

Adjust this if the picture is whitish or blackish.

Available range: -16 (black) to +16 (white).

• TINT

Adjust this if the appearance of flesh tone is unnatural. Available range: -16 to +16.

• SHARPNESS

Adjust this if the picture is indistinct.

Available range: 0 to +3.

• Y DELAY

Adjust this if the picture looks separately/overlapped.

Available range: -2 to +2.

4 Press ENTER.

A window for setting parameters appears.



Selected parameter

5 Press ▼ or ▲ to adjust the level of the parameter.

The higher value enhances the effect.

6 Press ENTER.

Repeat steps 3 to 6 if you want to set other parameters.

To clear the VFP mode window

Press VFP.

NOTES

- The VFP mode window disappears if no operation is made for about 10 seconds.
- While zoomed, VFP cannot be used.

Zooming in



1 During playback or while paused, press ZOOM.

At the top left of the screen, the information for the current magnification appears for about 5 seconds.

- Each time you press the button, the magnification becomes higher (1.8, 4, 8, 16, 32 and 64 times).

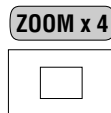

2 Press ► / ◀ / ▼ / ▲ to move the zoomed position.

To release the zoom

Press ENTER.

NOTES

- When a wide-screen picture of a DVD Video is viewed on a normal TV (4:3 Letter Box), black bars may appear at the top and bottom of the screen. In this case, if you select "ZOOM x 1.8," the black bars become almost invisible. When a 1:2.35 or 1:1.85 DVD Video source is played back, however, the black bars are still visible on the TV.
- While zoomed, the picture may look coarse.

Menu bar operations

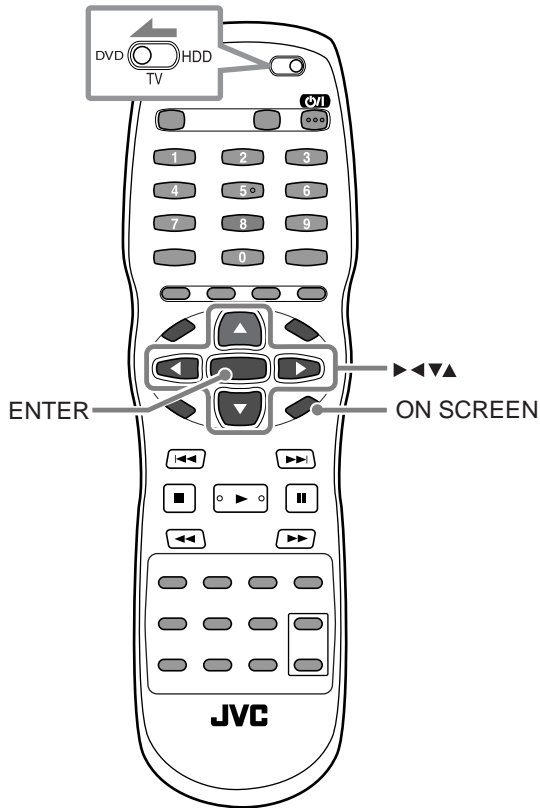

Precaution on the menu operation

If you show the menu bar while operating the disc menu, you may not be able to operate the disc menu correctly.
If this happens, clear the menu bar.

1 Show the status bar.

Press **ON SCREEN**.

- A status bar for the inserted disc appears on the TV (see page 48).
- See page 60 for details about the status bar.

2 Show the menu bar

Press **ON SCREEN** again.

- A menu bar for the inserted disc appears under the status bar.

(for DVD Video)



(for SVCD)



(for VCD)



(for CD)

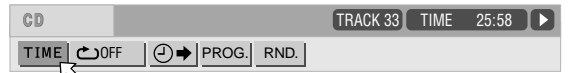

3 Select the icon you want to use

Press **▶** or **◀** to move  to the icon you want to use, then press **ENTER**.

- The pull-down window appears except for some functions.

4 Select or change the option for the selected icon.

- When the pull-down window is shown, press **▼** or **▲**, then press **ENTER**.
- When the pull-down window is not shown, press **ENTER**.
- For detailed operations for each icon on the menu bar, see the next page.

To clear the menu bar and status bar

Press **ON SCREEN** again.

NOTES

- The menu icon currently selected is shown in green.
- Some functions are not available during playback. (You cannot move  to the associated icon when it is not available.)

Menu bar functions for DVD Video

Time information

During playback, selects the time information shown in the display window and in the status bar.

Press **ENTER** to select the time information from the following.

- TIME: Current chapter elapsed time
- REM: Current chapter remaining time
- TOTAL: Current title elapsed time
- T.REM: Current title remaining time

Repeat Play (See also page 54)

Selects the repeat mode during playback.

1. Press **▼** or **▲** to select the repeat mode from the following.

- CHAPTER: Current chapter repeat
- TITLE: Current title repeat
- A-B: A-B repeat
- OFF: Repeat is cancelled

2. Press **ENTER** to activate Repeat Play.

Time search (See also page 52)

Specifies an elapsed playing time from the beginning of the current title as the point from which to begin playback.

Chapter search

During playback, specifies a desired chapter to play from.

1. Press number buttons (0 to 9) to enter a desired chapter number. (For example, to specify "10," press 1, then 0.)

2. Press **ENTER** to begin playback from the specified chapter.

Audio selection (See also page 56)

During playback, selects the audio language or sound track.

1. Press **▼** or **▲** to select a desired audio language or sound track.

2. Press **ENTER** to play with the selected audio.

Subtitle selection (See also page 56)

During playback, selects the subtitle language.

1. Press **▼** or **▲** to select a desired subtitle language.

2. Press **ENTER** to play with the selected subtitle.

Angle selection (See also page 56)

During playback, selects a desired scene angle in a multi-angle part.

1. Press **▼** or **▲** to select a scene angle.

2. Press **ENTER** to play with the selected scene angle.

Menu bar functions for SVCD/VCD/CD

Time information

Selects the time information shown in the display window and in the status bar.

Press **ENTER** to select the time information from the following.

- TIME: Current track elapsed time
- REM: Current track remaining time (while not playing, current track total time)
- TOTAL: Disc elapsed time
- T.REM: Disc remaining time (while not playing, disc total time)

Repeat Play (See also page 54)

Selects the repeat mode.

1. Press **▼** or **▲** to select the repeat mode from the following.

- TRACK: Current track repeat
- ALL: All track repeat
- A-B: A-B repeat (Only during play: see also page 55.)
- OFF: Repeat is cancelled

2. Press **ENTER** to activate Repeat Play.

Time search (See also page 52)

Specifies an elapsed playing time from the beginning of the disc as the point from which to begin playback.

Program Play (See also page 53)

Before starting playback, specifies the playback order of tracks.

Random Play (See also page 54)

Before starting playback, activates Random Play.

Audio selection (See also page 56)

During SVCD/VCD playback, selects the audio channel(s).

1. Press **▼** or **▲** to select a desired audio channel(s).

2. Press **ENTER** to play with the selected audio channel(s).

Subtitle selection (See also page 56)

During SVCD playback, selects the subtitle.

1. Press **▼** or **▲** to select a desired subtitle.

2. Press **ENTER** to play with the selected subtitle.

Playing an MP3 disc

The unit can play back MP3 files on a personally recorded CD-R/RW disc or commercially available disc. A disc that contains MP3 files is referred to as an "MP3 disc" in this manual.

Notice that if a disc contains both of MP3 and JPEG files, you can only play back files of the type selected by the "MP3/JPEG" setting in the "PICTURE" menu (see page 77).

About MP3 discs

In an MP3 disc, each song is recorded as a file (track). Files are sometimes grouped into folders by artists, album, etc.

- Each file is regarded as a track.
- A folder which has one or more files is regarded as a group.
- A folder which does not contain any tracks directly is ignored.
- Files which do not belong to any folder are grouped into "group 1."
- The unit recognizes up to 150 tracks per group, and up to 99 groups per disc. If there are files other than MP3 files, they are also counted in the 150-file total.

Tax. 99 groups per disc

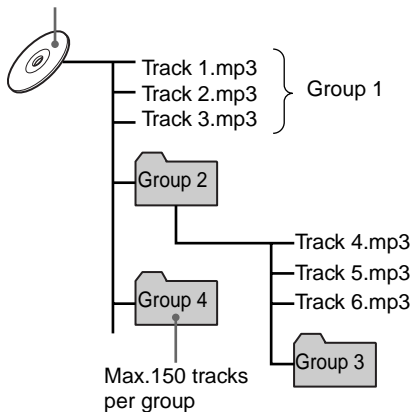

NOTE

- For making your own MP3 disc using a CD-R/CD-RW disc:
- Select "ISO 9660" as the disc format.
 - It is recommended to record your material at a 44.1 kHz sampling rate, using the 128 kbps data transfer rate.

Basic operations

Use the following buttons to operate an MP3 disc.

- ENTER:** Starts playback while stopped.
- ▶ (SELECT):** Starts playback while stopped or paused.
- (CLEAR):** Stops playback.
- II:** Pauses playback.
- ◀◀/▶▶:** Skips back or forward a file during playback. Selects the previous or next file while stopped.

- If you press **▶ (SELECT)** or **ENTER** during playback, the unit starts playback from the beginning of the current file.

NOTES

- The unit does not support "packet writing (UDF format)" discs.
- The unit does not support the ID3 tag.
- The unit supports discs recorded with multiple sessions.
- Some discs may not play due to disc characteristics or recording conditions.
- Program Play and Random Play cannot be used for MP3 discs.
- The unit can play back only tracks with the following file extensions; ".MP3," ".Mp3," ".mp3" and ".mP3."
- Time required for reading the disc contents may vary for different discs, depending on the numbers of groups (folders) and tracks (files) recorded, etc.
- You cannot advance or reverse playback by pressing **▶▶** or **◀◀**, or by holding down **▶▶** or **◀◀** during MP3 disc playback.

Operations using the MP3 CONTROL screen

When inserting an MP3 disc, the MP3 CONTROL screen automatically appears on the TV.

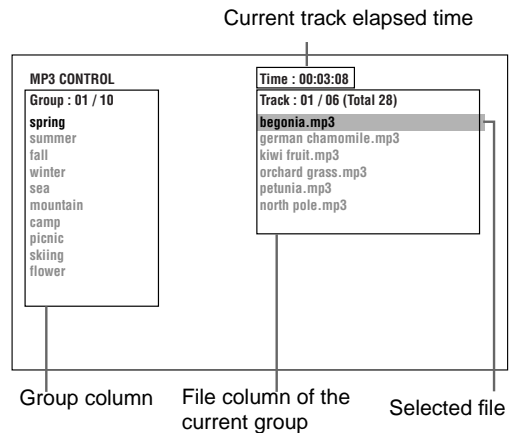

You can specify the desired group/file from the MP3 CONTROL screen using the following procedure.

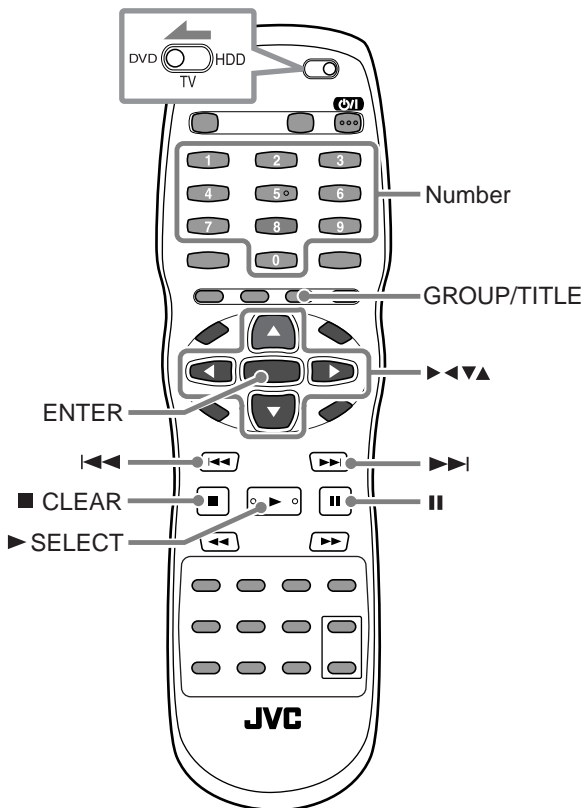
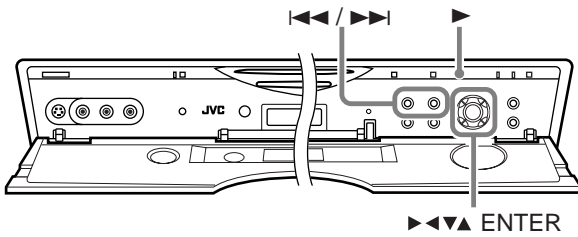

To select (highlight) a “Group” column or “Track” column on the screen, press ► or ◀.

To select a group, press cursor ▼ or ▲ when the cursor (highlighted bar) is in the “Group” column.

If there are unshown groups, they will appear in this column as you selecting groups.

- After pressing **GROUP/TITLE**, you can select the group number (up to 99) without respect to the cursor (highlighted bar) position.

Examples: To select 5: press **5**.

To select 23: press **2**, then **3**.

To select 40: press **4**, then **0**.

To select a file, press ▼ or ▲ when the cursor (highlighted bar) is in the “Track” column.

If there are unshown tracks, they will appear in this column as you selecting files.

- By pressing ►► or ◀◀, you can change the files without respect to the cursor (highlighted bar) position.
- By pressing the **number** buttons, you can select a file number (up to 99) directly, and start play from the selected file.

To start playing back a file, press ► (SELECT) or ENTER.

NOTE

If an MP3 file name includes any 2-byte character, the unit cannot show the file name correctly.

- When using the buttons on the unit, make sure that the DVD lamp on the unit is lit. If not, press **DVD/HDD** so that the DVD lamp lights.
- When using the remote control, slide the **DVD/TV/HDD** selector to the left (**DVD**), then press **ENTER**.

To repeat an MP3 file(s)

1 Press ON SCREEN once.

The pull-down menu for Repeat Play appears.

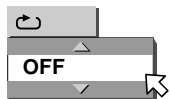

2 Press ▼ or ▲ to select an option you want, then press ENTER.

- TRACK: Current file repeat
- GROUP: Current group repeat
- ALL: All file repeat
- OFF: Repeat Play is cancelled

Selected repeat mode also appears on the MP3 CONTROL screen.

To start Repeat Play, press ► (SELECT) if necessary.

To stop repeat playback

Press ■ (CLEAR).

- The unit stops playback but does not cancel Repeat Play.

To cancel Repeat Play

Select "OFF" in step 2 above.

NOTE

When Repeat Play is selected, an appropriate repeat indicator also lights in the display window— or 1.

On-screen display	Display window
TRACK	1
GROUP or ALL	
OFF	No indication

Playing a JPEG disc

The unit can play back JPEG files on a personally recorded CD-R/RW disc.

A disc that contains JPEG files is referred to as a "JPEG disc" in this manual.

Notice that if a disc contains both of MP3 and JPEG files, you can only play back files of the type selected by the "MP3/JPEG" setting in the "PICTURE" menu (see page 77).

About JPEG discs

In a JPEG disc, each picture is recorded as a file. Files are sometimes grouped into folders by category, etc.

- A folder which has one or more files is regarded as a group.
- A folder which does not contain any files directly is ignored.
- Files which do not belong to any folder are grouped into "group 1."
- The unit recognizes up to 150 files per group, and up to 99 groups per disc. If there are files other than JPEG files, they are also counted in the 150-file total.

Tax. 99 groups per disc

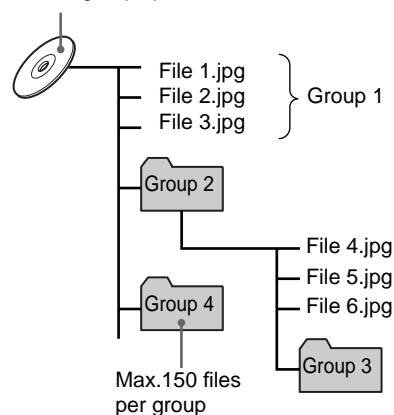

NOTE

For making your own JPEG disc using a CD-R/CD-RW disc:

- Select "ISO 9660" as the disc format.
- It is recommended to record your material at a 640 x 480 pixel resolution.
- This unit supports the baseline JPEG format.

Basic operations

Use the following buttons to operate a JPEG disc.

- ▶ (SELECT): Starts slide show while stopped or paused.
- (CLEAR) or MENU: Stops slide show.
- || or ENTER: Keep showing the same picture.
- ◀◀/▶▶: Skips back or forward a file during slide show.

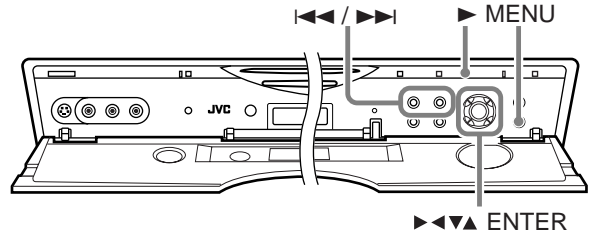

NOTES

- The unit supports the baseline JPEG format.
- The unit does not support "packet writing (UDF format)" discs.
- The unit supports discs recorded with multiple sessions.
- The unit may not be able to read some discs, or may take a long time to display a picture in the disc, due to disc characteristics, recording conditions, or numbers of groups (folders), etc.
- Program Play and Random Play cannot be used for JPEG discs.
- Screen Saver will be activated if the same picture is displayed for more than 5 minutes.
- The unit only can play back files with the following file extensions; ".jpg," ".jpeg," ".JPG," ".JPEG" and any other combination of upper case and lower case letters (such as ".Jpg").
- If a JPEG file name includes any 2-byte character, the unit may not show the file name correctly.
- If a picture has been saved at greater than 640 x 480 pixel resolution, it may take some time to display the picture.
- The unit does not support pixel size of more than 2400 pixels in horizontal resolution. Make sure that the horizontal resolution of the picture pixel size is 2400 pixels or less.

Operations using the JPEG CONTROL screen

When inserting a JPEG disc, the JPEG CONTROL screen automatically appears on the TV.

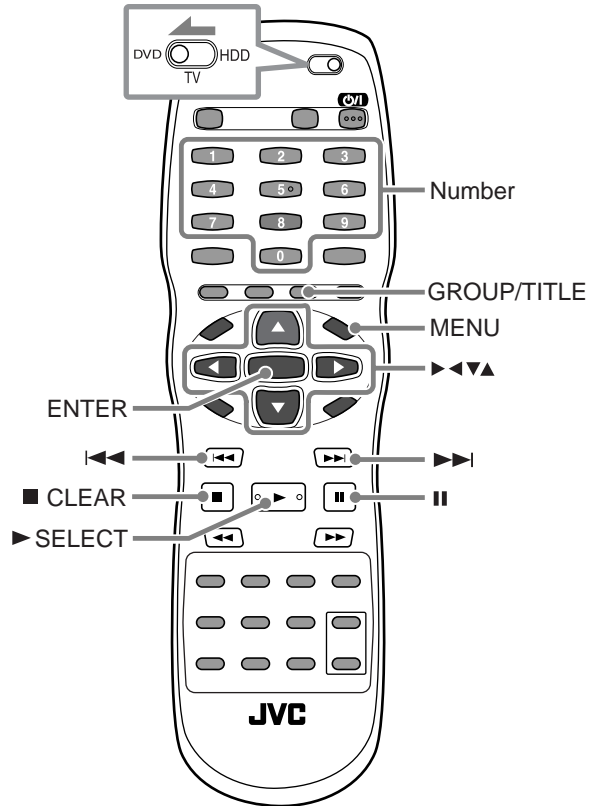
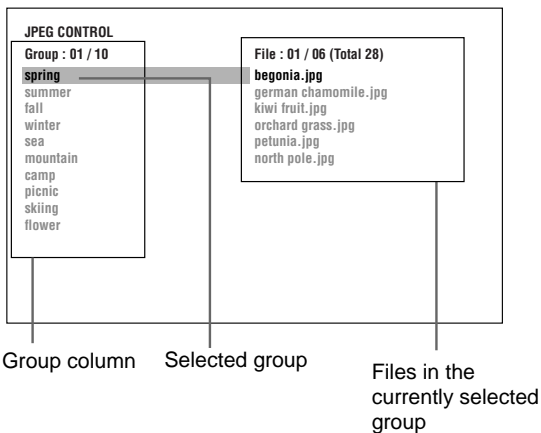

- When using the buttons on the unit, make sure that the DVD lamp on the unit is lit. If not, press **DVD/HDD** so that the DVD lamp lights.
- When using the remote control, slide the **DVD/TV/HDD** selector to the left (**DVD**), then press **ENTER**.

You can specify the desired group/file from the JPEG CONTROL screen using the following procedure.

To select (highlight) a “Group” column or “Track” column on the screen, press ► or ◀.

To select a group, press cursor ▼ or ▲ to move the cursor (highlighted bar) to a group you want when the cursor is in the “Group” column.

If there are unshown groups, they will appear in this column as you selecting groups.

- After pressing **GROUP/TITLE**, you can select the group number (up to 99) without respect to the cursor (highlighted bar) position.

Examples: To select 5: press **5**.

To select 23: press **2**, then **3**.

To select 40: press **4**, then **0**.

To select a file, press ▼ or ▲ to move the cursor (highlighted bar) to a file you want when the cursor is in the “Track” column.

If there are unshown tracks, they will appear in this column as you selecting files.

- By pressing ►► or ◀◀, you can change the files without respect to the cursor (highlighted bar) position.
- By pressing the **number** buttons, you can select a file number (up to 99) directly, and start slide show from the selected file.

To start slide show from the selected file (on the highlighted bar), press ► (SELECT).

To show the selected file (on the highlighted bar) as a still image, press ENTER.

To move to another file, press ►► or ◀◀.

NOTE

If the selected file is unplayable, a black screen appears.

To repeat the slide show

- 1 Before starting slide show or a still image, press ON SCREEN once.

The pull-down menu for Repeat Play appears.



- 2 Press ▼ or ▲ to select an option you want, then press ENTER.

- GROUP: Current group repeat
- ALL: All file repeat
- OFF: Repeat Play is cancelled

Selected repeat mode also appears on the JPEG CONTROL screen.

To start Repeat Play, press ► (SELECT).

To stop repeat playback

Press ■ (CLEAR).

- The unit stops playback but does not cancel Repeat Play.

To cancel Repeat Play

Select “OFF” in step 2 above.

NOTE

When Repeat Play is selected, an appropriate repeat indicator also lights in the display window—↻.

To zoom in the picture

- 1 Press II during slide show.

- 2 Press ZOOM.

- Each time you press the button, the magnification becomes higher (1.8, 4, 8, 16, 32 and 64 times).

- 3 Press ► / ◀ / ▼ / ▲ to move the zoomed position.

To release the zoom

Press ENTER.

NOTE

While zoomed, the picture may look coarse.

Changing the HDD/TV tuner settings

Without changing the HDD settings (which includes the built-in TV tuner setting), you can use the HDD deck. However, it is recommended to change them as you prefer so that the operation of this unit become easier and convenient.

The unit provides the three main setting items—HDD SET UP, FUNCTION SET UP, and INITIAL SET UP.

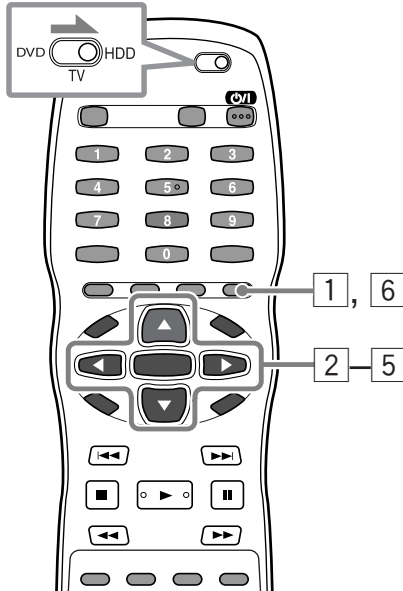

When using the remote control, slide the **DVD/TV/HDD** selector to the right (**HDD**), then press **ENTER**.

The table below shows the HDD and the built-in TV tuner setting items.

HDD SET UP	LIVE MEMORY (See page 67) AUDIO REC (See page 67) JUMP TIME (See page 67)
FUNCTION SET UP	FUNCTION (See page 67) • O.S.D. • DIRECT REC INPUT/OUTPUT (See page 68) • L-1 OUTPUT • L-1 INPUT • L-2 SELECT • L-2 INPUT • F-1 INPUT FAMILY (See page 68)
INITIAL SET UP	TUNER SET • AUTO CH SET (See page 70) • MANUAL CH SET (See page 71) INITIAL SET • CLOCK SET (See page 69) • GUIDE PROG SET (See page 69) • SAT CONTROL SET (See page 17)

Basic procedure

Example: To set “L-1 OUTPUT” to “S-VIDEO” under the “INPUT/OUTPUT” items of the “FUNCTION SET UP” menu.

1 Show the Main Setup screen.

Press **SET UP**.

- The HDD SET UP screen appears.

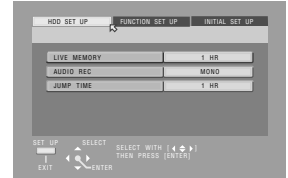

NOTE

- If the built-in clock has not been set, the INITIAL SET UP screen appears. If this happens, set the clock first (see page 69).

2 Select one of the main menu screen.

Press **▶** or **◀** to show one of the three main menu—HDD SET UP, FUNCTION SET UP, or INITIAL SET UP. (In this example, FUNCTION SET UP.)

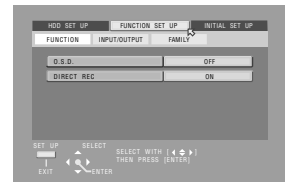

3 Select one of the sub-menu screens.

- ① Press **▼** to move **↔** to one of the sub-menu screens.
- ② Press **▶** or **◀** to move **↔** to your desired submenu. (In this example, select “INPUT/OUTPUT.”)



NOTE

When changing the HDD SET UP items, skip this step.

4 Select an item (in this example, “L-1 OUTPUT”) you want to change.

Press **▼** or **▲** to move **↔** to “L-1 OUTPUT,” then press **ENTER**.

5 Select an option for the setting.

Press **▼** or **▲** to select “S-VIDEO” (in this example), then press **ENTER**.

6 Finish the setting.

Press **SETUP** repeatedly until menu screens disappear.

HDD SET UP

- The initial setting is **bold** in the table below.

LIVE MEMORY	<p>You can change the temporary memory time length for Live Memory (see page 21).</p> <p>Setting options OFF, 30 MIN, 1 HR, and 3 HR</p>
AUDIO REC Setting options <ul style="list-style-type: none"> • NICAM • MONO 	<p>When this function is set to “NICAM,” the NICAM audio programmes will be received (or recorded). (See page 22.)</p> <p>When this function is set to “MONO,” the standard (monaural) audio programmes will be received (or recorded). If you receive a NICAM bilingual programme with this function set to “MONO,” the sound will be muted.</p> <p>NOTE This function works only for NICAM bilingual programme.</p>
JUMP TIME Setting options <ul style="list-style-type: none"> • 15 MIN • 30 MIN • 1 HR 	<p>You can locate a scene ahead or behind of the current one by jumping a selected time interval during playback (or Live Memory: Playback) or recording (or Live Memory: Recording).</p>

FUNCTION SET UP

O.S.D. Setting options <ul style="list-style-type: none"> • ON • OFF 	<p>With this function set to “ON,” various operational indicators (for HDD and TV tuner operations) appear on the TV for a while when you operate the HDD deck.</p> <p>NOTE • When you use this unit as the playback component for editing (dubbing to a VCR, etc.), be sure to set “O.S.D.” to “OFF” before starting.</p>
DIRECT REC Setting options <ul style="list-style-type: none"> • ON • OFF 	<p>When this function is set to “ON,” you can easily start recording the programme that you are watching on the TV (received by the TV itself, not through the TV tuner built in this unit) by pressing ● (record) on the unit (or by pressing ► (SELECT) while holding REC ● on the remote control).</p> <p>NOTES</p> <ul style="list-style-type: none"> • This function is possible only when a TV offering T-V Link, etc. is connected with a fully-wired 21-pin SCART cable. (See page 11.) • If “DIRECT REC” is set to “OFF,” follow the procedure described in “Basic Recording” (see page 23). • During Direct Recording, “- -” appears in the display window. • If a programme is recorded with Direct Recording, the station name will not be registered for HDD Navigation. “- - - -” will be shown for the station name. • To record S-Video signals through the L-2 IN or INPUT F-1 connector, make sure that “DIRECT REC” is set to “OFF”; otherwise, the recorded picture will lose colour.

INPUT/OUTPUT

<p>L-1 OUTPUT</p> <p><u>Setting options</u></p> <ul style="list-style-type: none"> • VIDEO • S-VIDEO 	<p>Set this correctly according to the external component connected to the L-1 IN/OUT connector. This setting affects only the output through the HDD and the build-in TV tuner.</p> <ul style="list-style-type: none"> • VIDEO: Select when the external component accepts composite video signals. • S-VIDEO: Select when the external component accepts S-video (Y/C) signals. You can obtain the better picture quality. (Be sure that a 21-pin SCART cable compatible with the Y/C signals is used for connection.) <p>NOTE</p> <ul style="list-style-type: none"> • If "L-1 INPUT" is set to "S-VIDEO," you cannot select "S-VIDEO" for "L-1 OUTPUT."
<p>L-1 INPUT</p> <p><u>Setting options</u></p> <ul style="list-style-type: none"> • VIDEO • S-VIDEO 	<p>Set this correctly according to the external component connected to the L-1 IN/OUT connector.</p> <ul style="list-style-type: none"> • VIDEO: Select when the external component emits composite video signals. • S-VIDEO: Select when the external component emits S-video (Y/C) signals. You can obtain the better picture quality. (Be sure that a 21-pin SCART cable compatible with the Y/C signals is used for connection.) <p>NOTE</p> <p>If "L-1 OUTPUT" is set to "S-VIDEO," you cannot select "S-VIDEO" for "L-1 INPUT."</p>
<p>L-2 SELECT</p> <p><u>Setting options</u></p> <ul style="list-style-type: none"> • A/V • SAT 	<p>Set this correctly according to the usage of the external component connected to the L-2 IN connector.</p> <ul style="list-style-type: none"> • A/V: Select when you use the HDD deck as the recording device or use the satellite receiver connected to the L-2 IN connector • SAT: Select when you want to view a satellite programme on the TV without turning on this unit. <p>NOTE</p> <ul style="list-style-type: none"> • When power failure occurs or when this unit is unplugged, this function is automatically reset to "A/V." • When a satellite receiver is not connected to the L-2 IN connector, set this function to "A/V." • "L-2 SELECT" is set to "SAT," "SAT" appears on the TV and in the display window (instead of "L-2").
<p>L-2 INPUT</p> <p><u>Setting options</u></p> <ul style="list-style-type: none"> • VIDEO • S-VIDEO 	<p>Set this correctly according to the external component connected to the L-2 IN connector.</p> <ul style="list-style-type: none"> • VIDEO: Select when the external component emits composite video signals. • S-VIDEO: Select when the external component emits S-video (Y/C) signals. You can obtain the better picture quality. (Be sure that a 21-pin SCART cable compatible with the Y/C signals is used for connection.)
<p>F-1 INPUT</p> <p><u>Setting options</u></p> <ul style="list-style-type: none"> • VIDEO • S-VIDEO 	<p>Set this correctly according to the type of connection made for the F-1 connector.</p> <ul style="list-style-type: none"> • VIDEO: Select when connecting the external component to the VIDEO jack. • S-VIDEO: Select when connecting the external component to the S-VIDEO jack.

FAMILY

<p>Family members</p> <p><u>Setting options</u></p> <ul style="list-style-type: none"> • ON • OFF 	<p>Set this to fit to your family. When shipped from the factory, all listed family members are set to "ON" so that they can be displayed on the CATEGORY screen for HDD Navigation.</p> <ul style="list-style-type: none"> • You can erase unnecessary family members from the CATEGORY screen by setting them to "OFF."
--	--

Setting the clock time

If you have performed Auto Setup (see page 13) or TV-Linked Setup (see page 14), the clock is set automatically. Set the clock manually in the following cases.

- When the clock time has not been set correctly by Auto Setup, TV-Linked Setup, or Auto Channel Set.
- When the backup memory is expired.
- When you want to change Just Clock* setting yourself.

* Just Clock

Just Clock provides accurate time keeping through automatic adjustments at regular intervals, by reading data from a PDC signal. It also automatically adjust the summer time setting.

- Just Clock adjusts the built-in clock every hour, except for 23:00, 0:00, 1:00 and 2:00.

NOTES

Just Clock does not work in the following cases:

- When the unit is turned on.
- When the unit stands by for the timer recording or Automatic Satellite Recording.
- When "L-2 SELECT" is set to "SAT."
- When the built-in clock moves more than 3 minutes slower or faster.
- When the signal reception is not good enough.

IMPORTANT: If you turn off Just Clock, the accuracy of the built-in clock may be reduced, which could adversely effect timer recording. It is recommended to turn "ON" Just Clock. However, where the clock setting data from a PDC signal is not accurate, turn "OFF" Just Clock.

- 1 Press **SET UP**.
- 2 Press **▶** or **◀** to move **↔** to "INITIAL SET UP," then press **▼**.
- 3 Press **▶** or **◀** to move **↔** to "INITIAL SET," then press **ENTER**.
- 4 Press **▼** or **▲** to move **↔** to "CLOCK SET," then press **ENTER**.
The Clock Set screen appears.

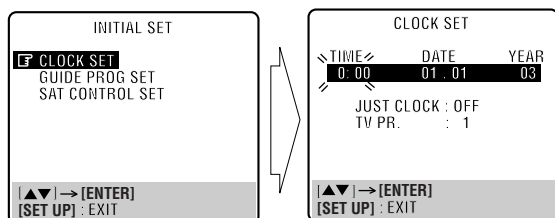

- 5 Press **▼** or **▲** to set the current time, then press **ENTER**.
 - If you hold **▼** or **▲**, the time changes in 30-minute intervals.

- 6 Press **▼** or **▲** to set the date, then press **ENTER**.
 - If you hold **▼** or **▲**, the date changes in 15-day intervals.
- 7 Press **▼** or **▲** to set the year, then press **ENTER**.
- 8 Press **▼** or **▲** to set Just Clock, then press **ENTER**.
 - Each time you press **▼** or **▲**, Just Clock turns "ON" and "OFF" alternately.
- 9 Press **▼** or **▲** to select the station from which you receive the clock setting signal.
 - Select the station transmitting the clock setting signal—BBC1, BBC2, Channel 4, etc.
- 10 Press **SET UP** twice to finish the setting.

Setting the Guide Program number for VIDEO PLUS+® System

Normally, Auto Setup (see page 13), TV-Linked Setup (see page 14) or Auto Channel Set (see page 70) sets the Guide Program numbers automatically. Set the Guide Program numbers manually in the following cases.

- When the VIDEO PLUS+® system cannot select the correct programme position number for the station you want to record.
- When you add a new station manually.
- When you want to record a satellite programme using the VIDEO PLUS+® system (Set the Guide Program numbers for all satellite broadcast stations which can be received on your satellite receiver.)

Guide programme number

"Guide programme (GUIDE PROG) number" refers to the assigned TV station numbers in your area for the VIDEO PLUS+® system. The Guide Program numbers can be found in most TV listings.

Example: When inputting Guide Program number 4 for CH4.

- 1 Press **SET UP**.
- 2 Press **▶** or **◀** to move **↔** to "INITIAL SET UP," then press **▼**.
- 3 Press **▶** or **◀** to move **↔** to "INITIAL SET," then press **ENTER**.
- 4 Press **▼** or **▲** to move **↔** to "GUIDE PROG SET," then press **ENTER**.
- 5 Press **▼** or **▲** to enter the Guide Program number for the desired station as shown in the TV listings, then press **ENTER**.

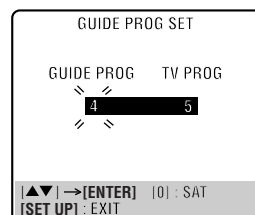

6 Press the number button “0” to select “TV PROG” or “SAT.”

- In this example, select “TV PROG.”
- Select “SAT” to enter a programme position number of the satellite receiver.

7 Press ▼ or ▲ to enter the programme position number for the station of the selected Guide Program number, then press ENTER.

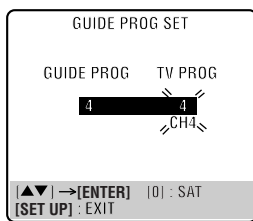

(Example) If CH4 is received on channel position 4.

This is the number you select on this unit or on the satellite receiver to tune into the station.

- To timer-record a satellite programme with the VIDEO PLUS+® system, install the supplied satellite controller and perform the procedure described on page 17.

8 Repeat steps 5 to 7 to store more Guide Program numbers.

9 Press SET UP twice to finish the setting.

Setting the built-in TV tuner

It is required to memorize all necessary stations in the programme positions in order to record TV programmes. Set the built-in TV tuner manually only in the following cases.

- When Auto Channel Set has not been performed correctly by Auto Setup or TV-Linked Setup.
- When you have moved to a different area or if a new station starts broadcasting in your area.

To set the built-in TV tuner automatically—Auto Channel Setup

Auto Channel Setup automatically assigns the programme position numbers to all receivable stations (their Guide Program numbers are also set automatically) during Auto Channel Setup in your area. These stations stored in the programme positions can be selected by using the **HDD/TV PR +/-** buttons (without going through any vacant programme positions).

1 Press SET UP.

2 Press ► or ◀ to move **↔** to “INITIAL SET UP,” then press ▼.

3 Press ► or ◀ to move **↔** to “TUNER SET,” then press ENTER.

4 Press ▼ or ▲ to move **↔** to “AUTO CH SET,” then press ENTER.

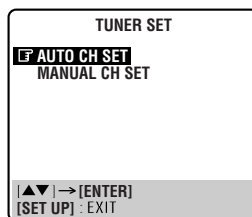

5 Press ▼ or ▲ to move **↔** to either “AUTO SET” or “T-V LINK,” then press ENTER or ►.

Auto Channel Setup starts.

- If you have connected the unit to a TV offering T-V Link via a 21-pin SCART cable, select “T-V LINK.”

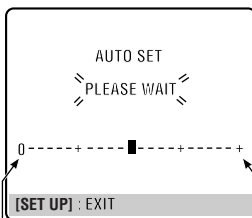

- As Auto Channel Setup progresses, the “■” mark on the AUTO SET screen moves from left to right.

When Auto Channel Setup is finished, the confirmation screen appears after the message “SCAN COMPLETED.”

PR	CH	ID	PR	CH	ID
01	26	BBC1	08	----	----
02	33	BBC2	09	----	----
03	23	ITV	10	----	----
04	30	CH4	11	----	----
05	37	CH5	12	----	----
06	----	----	13	----	----
07	----	----	14	----	----

At the bottom of the table, there are navigation instructions: [▲▼] ← [ENTER] : EDIT, → [CANCEL] : DELETE, [SET UP] : EXIT.

- The stations the unit has located appear on the confirmation screen— programme positions (PR), station channels (CH) and station names (ID—see pages 73 and 74). The confirmation screen and the programme currently being broadcasted by the flashing station appear alternately for about 8 seconds each. To view the other stations preset in the programme positions, press ► / ◀ / ▼ / ▲.

6 Press SET UP three times to finish the setting.

NOTES

- Using the confirmation screen, you can skip or add stations, enter station names and perform other operations. Refer to pages 71 to 73 for the procedures.
- This unit memorizes all detected stations even if reception of some of them is poor. You can delete those stations with an unacceptable picture (see page 71).
- Depending on reception conditions, stations may not be stored in order, and the station names and/or the Guide Program numbers may not be stored correctly. If the Guide Program numbers are not set properly when you timer-record a TV programme using the VIDEO PLUS+® system, the unit will not record a TV programme you want (see page 40).
- Fine tuning is performed automatically during Auto Channel Set. If you want to perform tuning manually, see page 72.
- If “SCAN COMPLETED –NO SIGNAL–” appears on the TV, make sure of the aerial connection, then press **ENTER**; Auto Channel Set will take place again.

To set the built-in TV tuner manually—Manual Channel Setup

You can store the station which cannot be stored using Auto Setup (see page 13), TV-Linked Setup (see page 14) or Auto Channel Setup (see page 70).

- 1 Press **SET UP**.
- 2 Press **▶** or **◀** to move **↔** to "INITIAL SET UP," then press **▼**.
- 3 Press **▶** or **◀** to move **↔** to "TUNER SET," then press **ENTER**.

- 4 Press **▼** or **▲** to move **☐** to "MANUAL CH SET," then press **ENTER**.

The confirmation screen appears.

- The confirmation screen and the programme currently being broadcast by the selected (flashing) channel appear alternately for about 8 seconds each.

PR	CH	ID	PR	CH	ID
01	26	BBC1	08	----	----
02	33	BBC2	09	----	----
03	23	ITV	10	----	----
04	30	CH4	11	----	----
05	37	CH5	12	----	----
06	----	----	13	----	----
07	----	----	14	----	----

▲▼◀▶ :
 → [ENTER] : EDIT
 → [CANCEL] : DELETE
 [SET UP] : EXIT

- 5 Press **▶** / **◀** / **▼** / **▲** to select an unoccupied programme position number in which you want to store a station, then press **ENTER**.

PR	CH	ID	PR	CH	ID
01	26	BBC1	08	----	----
02	33	BBC2	09	----	----
03	23	ITV	10	----	----
04	30	CH4	11	----	----
05	37	CH5	12	----	----
06	----	----	13	----	----
07	----	----	14	----	----

▲▼◀▶ :
 → [ENTER] : EDIT
 → [CANCEL] : DELETE
 [SET UP] : EXIT

(Example) To store in position 06.

- 6 Press **▼** or **▲** to select either regular TV station (CH) or cable system (CC), then press **▶**.

- Each time you press **▼** or **▲**, CH (regular TV station) and CC (cable system) alternately appears.

PR	CH	ID	FINE
06	CH21	----	+/-

▲▼ : SELECT
 ◀▶ : CURSOR
 [ENTER] : OK
 [SET UP] : EXIT

- 7 Press the number buttons to enter the station channel number you want to store.

- Enter "0" before any single number entries.
- To enter the preset station name (ID—see pages 73 and 74), press **▶** until "----" (ID setting) begins flashing, then press **▼** or **▲**. (To set station names other than the preset ones, see page 73.)
- For fine tuning adjustment, press **▶** repeatedly until "+/-" begins flashing, then press **▼** or **▲** for fine tuning. While tuning, "+" or "-" appears.

- 8 Press **ENTER** to store the new station.

The Confirmation screen appears.

- 9 Repeat steps 5 to 9 to store other new stations.

- 10 Press **SET UP** three times to finish the setting.

NOTE

Guide programme numbers are not set when the stations are stored manually. If you try to make a timer programming with the VIDEO PLUS+® system, "GUIDE PROGRAM IS NOT SET GUIDE PROG THEN RETRY" appears on the TV; set the Guide Program numbers (see page 72) manually.

To delete a station

- 1 Show the confirmation screen for Manual Channel Setup.

- ① Press **SET UP**.
- ② Press **▶** or **◀** to move **↔** to "INITIAL SET UP," then press **▼**.
- ③ Press **▶** or **◀** to move **↔** to "TUNER SET," then press **ENTER**.
- ④ Press **▼** or **▲** to move **☐** to "MANUAL CH SET," then press **ENTER**.

- 2 Press **▶** / **◀** / **▼** / **▲** to select a programme position number in which a station you want to delete is stored.

- 3 Press **CANCEL** to delete the station from the programme position.

The stored stations below the deleted station are re-assigned their programme positions.

- 4 Repeat steps 2 to 3 to delete all unnecessary stations.

- 5 Press **SET UP** three times to finish the setting.

To change the programme position number assigned to a station

1 Show the confirmation screen for Manual Channel Setup.

- ① Press **SET UP**.
- ② Press **▶** or **◀** to move **↔** to "INITIAL SET UP," then press **▼**.
- ③ Press **▶** or **◀** to move **↔** to "TUNER SET," then press **ENTER**.
- ④ Press **▼** or **▲** to move **☐** to "MANUAL CH SET," then press **ENTER**.

2 Press **▶** / **◀** / **▼** / **▲** to select a programme position number in which a station you want to move is stored, then press **ENTER**.

The channel number (under "CH") and station name (under "ID") start flashing.

3 Press **▶** / **◀** / **▼** / **▲** to select a new programme position number for the station you have selected, then press **ENTER**.

- Example: If you moved the station in position 4 to position 2, the stations originally in positions 2 and 3 are reassigned the new position numbers.

PR	CH	ID	PR	CH	ID
01	26	BBC1	08	----	----
02	23	ITV	09	----	----
03	30	CH4	10	----	----
04	33	BBC2	11	----	----
05	37	CH5	12	----	----
06	----	----	13	----	----
07	----	----	14	----	----

PR	CH	ID	PR	CH	ID
01	26	BBC1	08	----	----
02	33	BBC2	09	----	----
03	23	ITV	10	----	----
04	30	CH4	11	----	----
05	37	CH5	12	----	----
06	----	----	13	----	----
07	----	----	14	----	----

4 Repeat steps 2 and 3 as necessary.

5 Press **SET UP** three times to finish the setting.

To fine-tune the station channel

1 Show the confirmation screen for Manual Channel Setup.

- ① Press **SET UP**.
- ② Press **▶** or **◀** to move **↔** to "INITIAL SET UP," then press **▼**.
- ③ Press **▶** or **◀** to move **↔** to "TUNER SET," then press **ENTER**.
- ④ Press **▼** or **▲** to move **☐** to "MANUAL CH SET," then press **ENTER**.

2 Press **▶** / **◀** / **▼** / **▲** to select a programme position number in which a station you want to fine tune is stored, then press **ENTER**.

The channel number (under "CH") and station name (under "ID") start flashing.

3 Press **ENTER** again.

The Manual Channel Setup screen appears.

4 Press **▶** repeatedly until "+/-" begins flashing.

5 Press **▼** or **▲** to fine tune the picture to obtain the best picture.

6 Press **ENTER**.

The confirmation screen appears.

7 Repeat steps 2 to 6 to fine tune other stations.

8 Press **SET UP** three times to finish the setting.

To assign the station names

To assign the preset station names (see the tables on pages 73 and 74)

1 Show the confirmation screen for Manual Channel Setup.

- ① Press **SET UP**.
- ② Press **▶** or **◀** to move **↔** to "INITIAL SET UP," then press **▼**.
- ③ Press **▶** or **◀** to move **↔** to "TUNER SET," then press **ENTER**.
- ④ Press **▼** or **▲** to move **☐** to "MANUAL CH SET," then press **ENTER**.

2 Press **▼** or **▲** to select a programme position number in which a station you want to assign a name to is stored, then press **ENTER**.

The channel number (under "CH") and station name (under "ID") start flashing.

3 Press **ENTER** again.

The Manual Channel Setup screen appears.

4 Press **▶** repeatedly until the station name (under "ID") starts flashing.

5 Press **▼** or **▲** to select a new station name.

- Each time you press the button, preset names change.



PR	CH	ID	FINE
06	CH45	----	+/-

▲▼ : CHANGE ID ◀▶ : CURSOR←→ [ENTER] : OK [SET UP] : EXIT
--

6 Press ENTER.

The confirmation screen appears

7 Repeat steps 2 to 6 to change other station names.**8** Press SET UP three times to finish the setting.**To assign your own station names****1** Show the confirmation screen for Manual Channel Setup.

- ① Press SET UP.
- ② Press ► or ◀ to move  to "INITIAL SET UP," then press ▼.
- ③ Press ► or ◀ to move  to "TUNER SET," then press ENTER.
- ④ Press ▼ or ▲ to move  to "MANUAL CH SET," then press ENTER.

2 Press ▼ or ▲ to select a programme position number in which a station you want to assign a name to is stored, then press ENTER.

The channel number (under "CH") and station name (under "ID") start flashing.

3 Press ENTER again

The Manual Channel Setup screen appears.

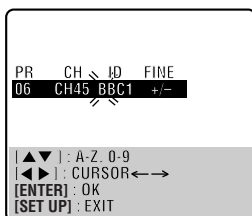
4 Press ► repeatedly until the station name (under "ID") starts flashing.**5** Press ► once so that the first character position for station name (under "ID") starts flashing.**6** Press ▼ or ▲ to select a character you want, then press ►.

- Each time you press ▼ or ▲, A–Z, 0–9, –, *, +, and _ (space) appears in sequence.
- Repeat this step to assign a name (up to 4 characters).
- To correct a mis-entry, press ◀ (or ▶) until the incorrect character starts flashing, then press ▼ or ▲ to enter the correct character.

7 Press ENTER.

The confirmation screen appears.

8 Repeat steps 2 to 7 to change other station names.**9** Press SET UP three times to finish the setting.**TV station and ID list**

Station name	ID*
Anglia TV	ANGL
ARD	ARD
ARTE	ARTE
BBC Group	BBC
BBC1	BBC1
BBC2	BBC2
Berlin 1	BLN1
Berlin 2	BLN2
Border TV	BORD
Bayern1	BR1
Bayern3	BR3
BRT1	BRT1
BRT2	BRT2
Children Ch	CHLD
Canal +	CH+
CNN	CNN
Channel TV	CHNL
Central TV	CNTR
Channel 4	CH 4
Channel 5	CH 5
DRS	DRS
DR TV	DRTV
DSF	DSF
Euronews	EURN
Euronews	EURO
Eurosports	EURS
France1	FR1
France2	FR2
France3	FR3
Granada TV	GRNA
Grampian TV	GRMP
Hessen1	HR1
Hessen3	HR3
HRT	HRT
HTV	HTV
ITV Network	ITV
Kabelkanal	KABL
London	LNDN
MDR	MDR
MTV	MTV
Nord3	N3
NDR1	NDR1
NDR3	NDR3
NED1	NED1
NED2	NED2
NED3	NED3
Network 2	NET2
NRK	NRK
N-TV	N-TV
Offener Kanal	OKAN
ORF1	ORF1
ORF2	ORF2
ORF3	ORF3
OWL 3	OWL3
Premiere	PRM1
PR07	PR07
RAI1	RAI1
RAI2	RAI2
RAI3	RAI3
RB1	RB1
RB3	RB3
Rikisutvarpid-S	RKPS
RTBF 1	RTB1
RTBF 2	RTB2
RTE 1	RTE1
RTL	RTL
RTL 2	RTL2
RTP	RTP

Station Name	ID*
SAT	SAT
SAT 1	SAT1
Scottish TV	SCOT
SC4	SC4
SDR	SDR
SDR1	SDR1
SFB1	SFB1
SFB3	SFB3
SKY	SKY
Sky One	SKY1
Sky Net	SKYN
Sport	SPRT
SR 1	SR1
Super RTL	SRTL
STV Test	STVT
STV 1	STV1
STV 2	STV2
Suedwest3	SWR
SWF 1	SWF1
Schweiz4	SWZ4
TYNE TEES	TEES
Text	TEXT
TF1	TF1
TNT int	TNT
TRT int	TRT
TSI	TSI
TSR	TSR
TSW	TSW
TVE	TVE
TV Polonia	TVPA
TVP 1	TVP1
TVP 2	TVP2
TVS	TVS
TV2	TV2
TV5	TV5
Tele Zurich	TZUR
Ulster TV	ULST
Veronica	VERN
VIVA	VIVA
VIVA2	VIV2
VOX	VOX
VTM	VTM
VT4	VT4
West1	WDR1
West3	WDR3
YLE 1	YLE1
YLE 2	YLE2
Yorkshire TV	YORK
ZDF	ZDF
Zurich 1	ZUR1
3SAT	3SAT

* The "ID" abbreviation listed in the confirmation screen appears on the TV when the built-in tuner is tuned to the station.

TV station channel number guide

Only the main stations are listed. There are in addition many relay stations, and full lists are available from the BBC and ITV.

	BBC1	BBC2	ITV	CH4	CH5
London & South-East					
Bluebell Hill.....	40	46	43	65	—
Crystal Palace.....	26	33	23	30	37
Dover.....	50	56	66	53	—
Heathfield.....	49	52	64	67	—
Oxford.....	57	63	60	53	49

South-West					
Beacon Hill.....	57	63	60	53	—
Caradon Hill.....	22	28	25	32	—
Huntslaw Cross.....	55	62	59	65	67
Redruth.....	51	44	41	47	37
Stockland Hill.....	33	26	23	29	—
Channel Islands					
Fremont Point.....	51	44	41	47	—
South					
Hannington.....	39	45	42	66	35
Midhurst.....	61	55	58	68	—
Rowridge.....	31	24	27	21	—
West					
Mendip.....	58	64	61	54	37
East					
Sandy Heath.....	31	27	24	21	39
Sudbury.....	51	44	41	47	35
Tacolnaston.....	62	55	59	65	52
Midlands					
Ridge Hill.....	22	28	25	32	35
Sutton Coldfield.....	46	40	43	50	37
The Wrekin.....	26	33	23	29	35
Waltham.....	58	64	61	54	35
North					
Belmont.....	22	28	25	32	56
Emley Moor.....	44	51	47	41	37
	BBC1	BBC2	ITV	CH4	CH5
North-West					
Caldbeck.....	30	34	28	32	56
Winter Hill.....	55	62	59	65	48
North-East					
Bilsdale West Moor.....	33	26	29	23	35
Chatton.....	39	45	49	42	—
Pontop Pike.....	58	64	61	54	68
Scotland					
Angus.....	57	63	60	53	—
Black Hill.....	40	46	43	50	37
Sandale.....	22	—	—	—	—
Caldbeck.....	—	34	28	32	56
Creigkelly.....	31	27	24	21	48
Darvel.....	33	26	23	29	35
Durris.....	22	28	25	32	67
Eitshal.....	33	26	23	29	—
Keelylang Hill.....	40	46	43	50	—
Knock More.....	33	26	23	29	—
Rosemarkie.....	39	45	49	42	67
Rumster Forest.....	31	27	24	21	—
Selkirk.....	55	62	59	65	52
Wales					
Blaenplwyf.....	31	27	24	21	56
Carmel.....	57	63	60	53	—
Llanddona.....	57	63	60	53	—
Moel-y-Parc.....	52	45	49	42	—
Presely.....	46	40	43	50	37
Wenvoe.....	44	51	41	47	—
Northern Ireland					
Brougher Mountain.....	22	28	25	32	—
Divis.....	31	27	24	21	37
Limavady.....	55	62	59	65	—

Changing the DVD settings

Without changing the DVD settings, you can use the DVD player.

However, it is recommended to change them as you prefer so that the operation of this unit become easier and convenient.

The unit provides the four main setting items—LANGUAGE, PICTURE, AUDIO, and OTHERS.

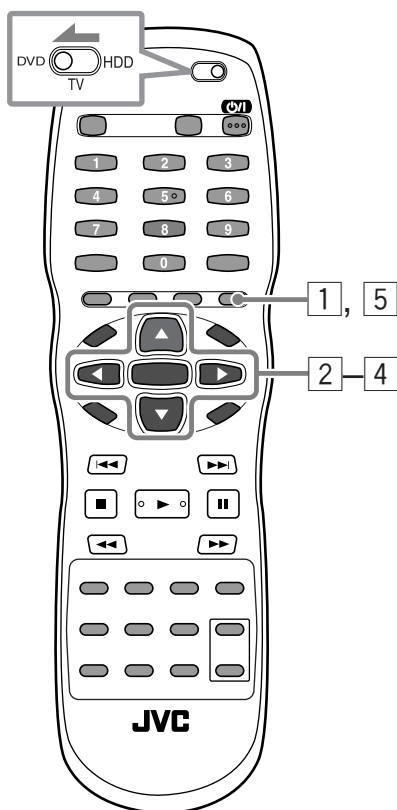

When using the remote control, slide the **DVD/TV/HDD** selector to the left (**DVD**), then press **ENTER**.

The table below shows the DVD setting items.

LANGUAGE (See page 76)	MENU LANGUAGE AUDIO LANGUAGE SUBTITLE
PICTURE (See page 77)	MONITOR TYPE PICTURE SOURCE SCREEN SAVER MP3/JPEG
AUDIO (See page 78)	DIGITAL AUDIO OUTPUT ANALOG DOWN MIX D. RANGE CONTROL OUTPUT LEVEL
OTHERS (See page 79)	RESUME ON SCREEN GUIDE AV COMPULINK MODE PARENTAL LOCK

Basic procedure

Example: To change “MP3/JPEG” to “JPEG.”

NOTE

The DVD Setup menu screen will not be shown when an MP3 or JPEG disc is loaded.

1 Show the DVD Setup menu screen.

Press **SET UP**.

- The LANGUAGE menu screen appears.

2 Select one of the DVD Setup menu screens.

Press **▶** or **◀** to select one of the four main menus—LANGUAGE, PICTURE, AUDIO, and OTHERS. (In this example, PICTURE.)

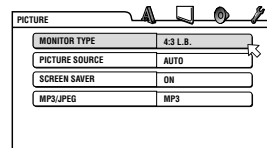

3 Select an item you want to change.

Press **▼** or **▲** to move **▶** to one of the items on the main menu screen, then press **ENTER**.

(In this example, select “MP3/JPEG.”)

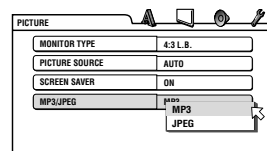

4 Select an option for the setting.

Press ▼ or ▲ to select “JPEG” (in this, example), then press ENTER.

5 Finish the setting.

Press SET UP.

- The initial setting is **bold** in the table below.

LANGUAGE

You cannot select and change the language settings during playback.

MENU LANGUAGE	<p>You can select the default menu language to be displayed if it is contained in a DVD Video disc.</p> <p>Setting options ENGLISH, SPANISH, FRENCH, CHINESE, GERMAN, ITALIAN, JAPANESE, and language code from AA to ZU</p> <p>NOTES</p> <ul style="list-style-type: none"> • If the disc does not have a menu in the selected language, the disc’s default language will be used. • For details about language codes, see “Table of languages and their abbreviations” on page 92.
AUDIO LANGUAGE	<p>You can select the default audio language to be reproduced if it is contained in a DVD Video disc.</p> <p>Setting options ENGLISH, SPANISH, FRENCH, CHINESE, GERMAN, ITALIAN, JAPANESE, and language code from AA to ZU</p> <p>NOTES</p> <ul style="list-style-type: none"> • If the disc does not have the selected language, the disc’s default language will be used. • For details about language codes, see “Table of languages and their abbreviations” on page 92.
SUBTITLE	<p>You can select the default subtitle language to be displayed if it is contained on a DVD Video disc.</p> <p>Setting options OFF, ENGLISH, SPANISH, FRENCH, CHINESE, GERMAN, ITALIAN, JAPANESE, and language code from AA to ZU</p> <p>NOTES</p> <ul style="list-style-type: none"> • If the disc does not have a subtitle in the selected language, the disc’s default language will be used. • For details about language codes, see “Table of languages and their abbreviations” on page 92.

PICTURE

<p>MONITOR TYPE</p> <p><u>Setting options</u></p> <ul style="list-style-type: none"> • 16:9 NORMAL • 16:9 AUTO • 4:3 LB • 4:3 PS 	<p>You can select the monitor type to match your TV when you play back a DVD Video recorded for wide-screen televisions.</p> <ul style="list-style-type: none"> • 16:9 NORMAL (Wide television screen): Select when you connect the unit to a wide-screen (16:9) TV whose aspect ratio is fixed to 16:9 (the unit automatically adjusts the screen width of the output signal correctly when playing back 4:3 software). If you play 4:3 software, the picture quality changes slightly due to the process for converting the picture width. • 16:9 AUTO (Wide television screen): Select when you connect the unit to a wide-screen (16:9) TV which can automatically adjust the screen size according to the incoming signals. • 4:3 LB (Letter Box conversion): Select when you connect the unit to a conventional (4:3) TV. When playing back DVD Video software recorded in wide picture format, the picture is shown with black bars at the top and bottom. • 4:3 PS (Pan Scan conversion): Select when you connect the unit to a normal (4:3) TV. When playing back DVD Video software recorded in wide picture format, the picture is zoomed to fill the screen vertically, and the left and right sides of the picture are cut off. <p>NOTE The picture will be shown in "4:3 LB" depending on the disc even if you select "4:3 PS."</p>
<p>PICTURE SOURCE</p> <p><u>Setting options</u></p> <ul style="list-style-type: none"> • VIDEO(NORMAL) • VIDEO(ACTIVE) • FILM • AUTO 	<p>This mode selects whether the content in the disc is processed by field (video source) or by frame (film source.) You can obtain optimal picture quality according to the source type to be played back by selecting an appropriate option.</p> <ul style="list-style-type: none"> • VIDEO(NORMAL): Select when playing back a video source disc with relatively a few movements. • VIDEO(ACTIVE): Select when playing back a video source disc with relatively a lot of movements. • FILM: Select when playing back a film source disc. • AUTO: Normally select this. When playing back a disc containing both video and film source materials, the unit recognizes the picture type (film or video source) of the current picture, and selects an appropriate mode automatically.
<p>SCREEN SAVER</p> <p><u>Setting options</u></p> <ul style="list-style-type: none"> • ON • OFF 	<p>The TV screen may have an image burned on it if a static image is displayed for a long time. To prevent this, set this function to "ON." The unit automatically activates Screen Saver, and dims the TV screen if a static picture, such as an on-screen display or menu, is displayed for over 5 minutes.</p> <p>Pressing any button will cancel Screen Saver temporarily.</p>
<p>MP3/JPEG</p> <p><u>Setting options</u></p> <ul style="list-style-type: none"> • MP3 • JPEG 	<p>The unit can play MP3 and JPEG files recorded in a CD-R/CD-RW disc. However, if a disc contains both MP3 and JPEG files, you need to select which files to play.</p> <ul style="list-style-type: none"> • MP3: Select to play back MP3 files. • JPEG: Select to play back JPEG files.

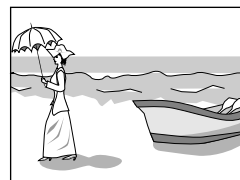
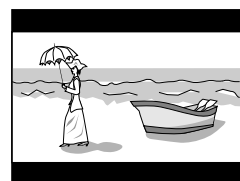
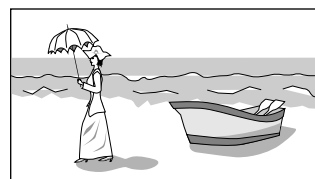

AUDIO

<p>DIGITAL AUDIO OUTPUT</p> <p><u>Setting options</u></p> <ul style="list-style-type: none"> • PCM ONLY • DOLBY DIGITAL/PCM • STREAM/PCM 	<p>Set this correctly according to the external component connected to the DIGITAL OUT connectors on the rear.</p> <ul style="list-style-type: none"> • See “Digital output signal chart” on page 92 for details about the relation between the setting and output signals. • PCM ONLY: Select when connecting to the linear PCM digital input connector of other audio equipment such as an MD recorder. • DOLBY DIGITAL/PCM: Select when connecting the digital input connector of a Dolby Digital decoder or an amplifier with a built-in Dolby Digital decoder. • STREAM/PCM: Select when connecting the digital input connector of an amplifier with a built-in DTS, MPEG Multichannel or Dolby Digital decoder, or the stand-alone unit of such a decoder.
<p>ANALOG DOWN MIX</p> <p><u>Setting options</u></p> <ul style="list-style-type: none"> • DOLBY SURROUND • STEREO 	<p>To correctly play the audio in a DVD Video disc recorded with surround multichannel audio, set this properly according to your audio system configuration.</p> <ul style="list-style-type: none"> • DOLBY SURROUND: Select when listening to multichannel surround audio through a surround decoder connected to the DVD/HDD AUDIO OUT and L-1 IN/OUT connectors on the rear. • STEREO: Select when listening to conventional two-channel stereo audio through an amplifier or receiver connected to the DVD/HDD AUDIO OUT and L-1 IN/OUT connectors on the rear. You can also connect a MiniDisc recorder, cassette deck, etc. to record through the DVD/HDD AUDIO OUT (and L-1 IN/OUT) connectors on the rear. <p>NOTE</p> <p>This function does not take effect when 3D PHONIC is activated.</p>
<p>D. RANGE CONTROL</p> <p><u>Setting options</u></p> <ul style="list-style-type: none"> • WIDE RANGE • NORMAL • TV MODE 	<p>This setting provides optimal audio quality through the DVD/HDD AUDIO OUT and L-1 IN/OUT connectors on the rear, for listening to DVD Video discs recorded in Dolby Digital format, at low or middle volume.</p> <ul style="list-style-type: none"> • WIDE RANGE: Select to enjoy powerful playback sound with the widest dynamic range. • NORMAL: Normally, select this. • TV MODE: Select if DVD Video disc sound level is lower than TV programme sound level. Thus you can hear sound at a lower volume clearly.
<p>OUTPUT LEVEL</p> <p><u>Setting options</u></p> <ul style="list-style-type: none"> • STANDARD • LOW 	<p>This setting allows you to attenuate the level of the signal output through the DVD/HDD AUDIO OUT and L-1 IN/OUT connectors on the rear.</p> <ul style="list-style-type: none"> • STANDARD: Normally, select this. • LOW: Select if the reproduced sounds are distorted.

OTHERS

<p>RESUME</p> <p><u>Setting options</u></p> <ul style="list-style-type: none"> • ON • OFF • DISC RESUME 	<p>You can select the resume playback mode.</p> <p>See page 49 for details about the resume playback function.</p>
<p>ON SCREEN GUIDE</p> <p><u>Setting options</u></p> <ul style="list-style-type: none"> • ON • OFF 	<p>The unit can display “on-screen guide” icons.</p> <p>See page 48.</p>
<p>AV CMOPULINK MODE</p> <p><u>Setting options</u></p> <ul style="list-style-type: none"> • DVD 1 • DVD 2 • DVD 3 	<p>This function is provided for the future use. Set this to “DVD1.”</p>
<p>PARENTAL LOCK</p>	<p>When this option is selected, pressing ENTER on the remote control brings up the PARENTAL LOCK screen. This allows you to restrict children from playing DVD Video discs.</p> <ul style="list-style-type: none"> • See following pages for details about the parental lock setting. <p>NOTE</p> <p>You cannot select this item during play.</p>

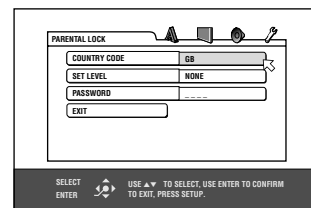

Limiting playback by children

This function restricts playback of DVD Video discs which contain violent (and other) scenes according to the level set by the user. For example, if a movie which includes violent scenes supports the parental lock feature, such scenes which you do not want to let children view can be cut or replaced with other scenes (this depends on how the disc is programmed).

Setting Parental Lock

DVD
Video

1 Show the OTHERS menu.



- ① Press **SET UP**.
- ② Press **▶** or **◀** to select "OTHERS."

2 Enter the PARENTAL LOCK screen.

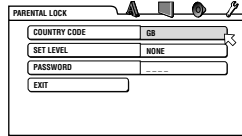
Press **▼** or **▲** to move  to "PARENTAL LOCK," then press **ENTER**.



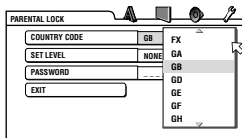

3 Select the country code.

- ① Press **▼** or **▲** to move  to "COUNTRY CODE," then press **ENTER**.
 - The pull-down menu appears.
- ② Press **▼** or **▲** to select the country code.
 - Select the code of the country whose standards were used to rate the DVD Video disc content. See "Country/Area code list for Parental Lock" on page 91.
- ③ Press **ENTER**.
 -  moves down to "SET LEVEL."



4 Select the level.

- ① Press **ENTER** again.
 - The pull-down menu appears. In the pull-down menu, "NONE" and levels "8" to "1" are available.
- ② Press **▼** or **▲** to move  to select a desired level.
 - "NONE" does not restrict playback. Level "1" is the strictest level. Discs rated higher than the selected level are restricted.
- ③ Press **ENTER**.
 -  moves down to "PASSWORD."

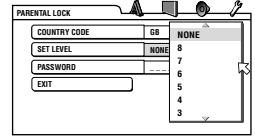

5 Enter your password.

Press the **number** buttons (0 to 9) to enter any 4-digit number.

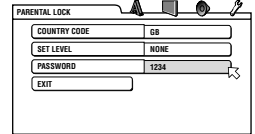







6 Finish the setting

- ① Press **ENTER**.
 - Parental Lock is set, and  moves down to "EXIT."
- ② Press **ENTER** again.
 - The OTHERS menu screen appears.

To change the settings

You can change the parental lock settings later.

- 1 Press SET UP.**
- 2 Press ► or ◀ to move  to "OTHERS."**
- 3 Press ▼ or ▲ to move  to "PARENTAL LOCK," then press ENTER.**
The PARENTAL LOCK screen appears.
- 4 While  is pointing to "PASSWORD," press the number buttons to enter your current 4-digit password, then press ENTER.**
 moves to "COUNTRY CODE" if you enter the correct password.
 - If you enter a wrong password, "WRONG! RETRY..." appears at the bottom of the screen, and you cannot go to the next step.
 - If you forget your password, enter "8888." The current password is deleted and you can set a new password.
- 5 To change the COUNTRY CODE or SET LEVEL setting, press ENTER to enter the associated pull-down menu when  is pointing to the desired item.**
- 6 Press ▼ or ▲ to select the desired option then press ENTER.**
 - If you change the country code, you must reselect the parental lock level.
- 7 While  is pointing to "PASSWORD," press the number buttons to enter a 4-digit password.**
The password entered in this step becomes the new password.
 - If you want to keep the same password as before, enter the same password.
- 8 Press ENTER.**
 moves to "EXIT."
- 9 Press ENTER again.**
The OTHERS menu screen appears.

NOTE

If you enter the wrong password more than three times in step 4 above,  moves to "EXIT" automatically and ▲/▼ do not work. Press **ENTER** to exit.

To temporarily release Parental Lock

If the parental level is set to a strict value, some discs may not play at all.

When you insert such a disc and try to play it, the following Parental Lock screen appears on the TV, asking you whether you want Parental Lock to be temporarily released or not.

- 1 Press ▼ or ▲ to move  to "TEMPORARY RELEASE," then press ENTER.**

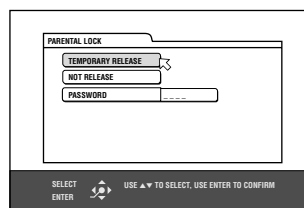

- 2 Press the number buttons (0 to 9) to enter your 4-digit password.**
The parental lock is released, and the unit starts playback.
 - If you enter a wrong password, "WRONG! RETRY..." appears at the bottom of the screen. Enter the correct password.

NOTE

When you enter the wrong password three times at step 2 above,  moves to "NOT RELEASE" automatically and ▲/▼ do not work. If this happens, press **EJECT** to eject the disc.

Setting the remote control code

When you use more than two JVC video products, a product which you have not intended to operate may correspond to the signals sent from this remote control. This occurs since the other JVC products accept the signals sent from this remote control.

To avoid this interference, you can change the remote control code both for the remote control and the unit.

- JVC supports four types of signal codes—A, B, C, and D. This unit and the remote control are initially set to C code.

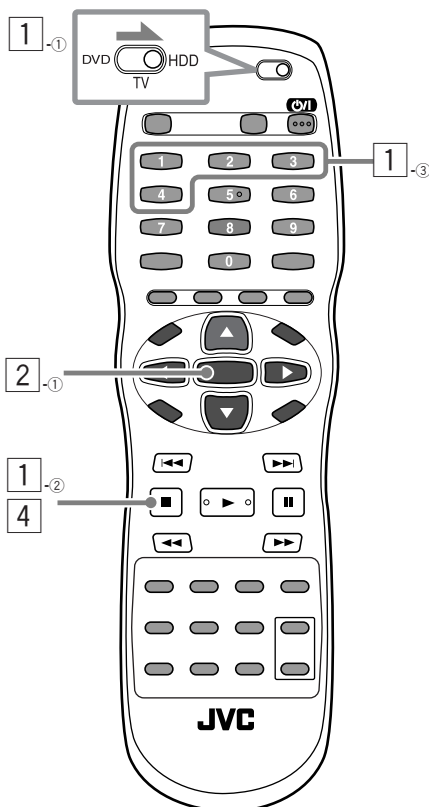
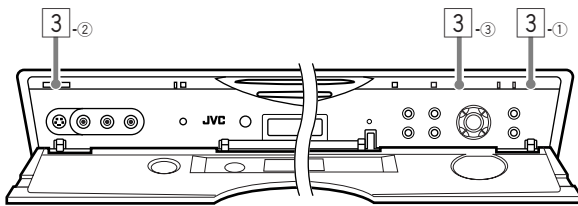

On the remote control

1 Change the remote control code.

- Slide the **DVD/TV/HDD** selector to the right (**HDD**).
- Press and hold **■ (CLEAR)** until step 3 is finished.
- Press the **number** button "1," "2," "3," or "4."
 - 1 for A code, 2 for B code, 3 for C code, and 4 for D code.

2 Set the remote control code for the remote control.

- Press **ENTER**.
- Release **■ (CLEAR)**.

On the unit

3 Show the code in the display window.

- If the DVD lamp on the unit is lit, press **DVD/HDD** so that the HDD lamp lights.
- Press **⏻/I STANDBY/ON** to turn off the unit.
- Press and hold **▶** for more than 5 seconds.
 - The current code appears in the display window.

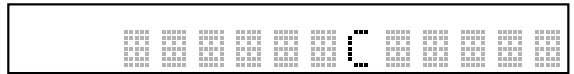

On the remote control

4 Change the remote code for the unit.

Aim the remote control to the remote sensor on the front panel, then press **■ (CLEAR)** on the remote control.

- The new code appears in the display window, and the unit now corresponds to this new signal code.



(Example) When you press number button 4 in step 1-3

Editing from a camcorder

Connection using the VIDEO connector

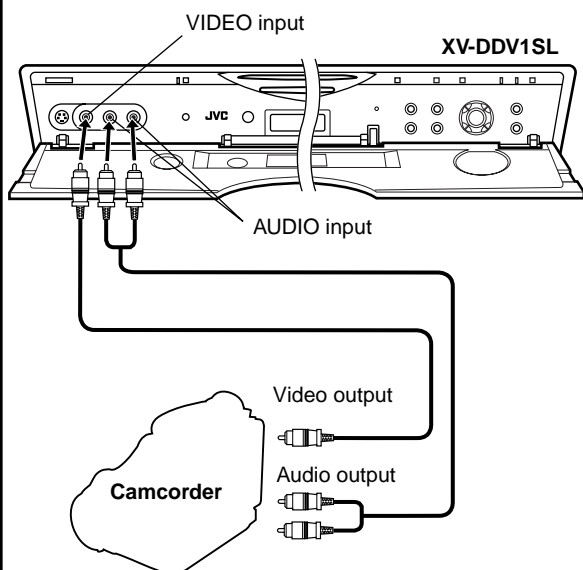

Connection using the S-VIDEO connector

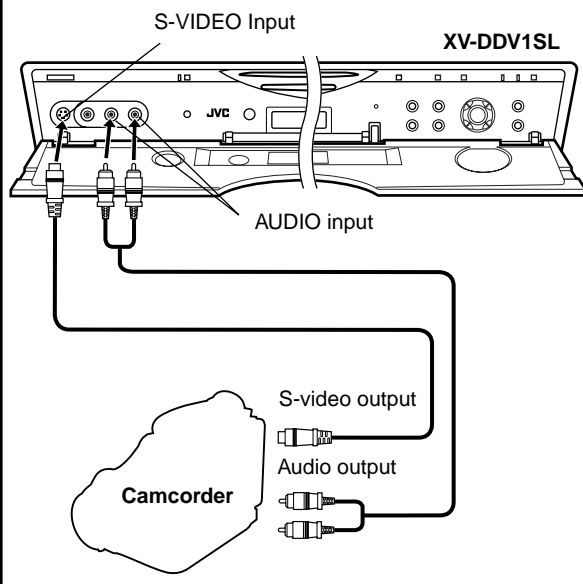

Precaution before editing onto the HDD

The picture shown on the TV is a few seconds behind the scene currently recorded onto the HDD. Therefore, if you start recording at the desired scene on the TV, you will miss the beginning of the scene by a few seconds. On the other hand, when you stop recording, you will record some extra scenes.

You can use a camcorder as the playback component and the HDD as the recording deck.

1 Make connections.

- See the connection diagrams to the left.

NOTE

When using a monaural camcorder, connect its audio output connector to the INPUT F-1 AUDIO L(MONO) connector on the front panel.

2 Select the HDD deck.

On the remote control

Set the DVD/TV/HDD selector set to the right (HDD), then press ENTER (or LIVE).

On the unit

Press DVD/HDD so that the HDD lamp lights.

3 Select the input mode.

On the remote control

Press AUX (number button "0") and/or HDD/TV PR +/- to select "F-1."

On the unit

Press PR +/- to select "F-1."

NOTES

- Set "F-1 INPUT" to "VIDEO" or "S-VIDEO" correctly according to which terminals are used for connection (see page 68).
- When connecting a TV with TV-Link or with equivalent function (see page 15) using the SCART cable, "DIRECT REC" is set to "OFF" (see page 67).

4 Start playback on the camcorder.

- Refer to the instruction manuals supplied with the camcorder.

5 Start recording on the HDD deck.

On the remote control

Press and hold REC ●, then press ►.

On the unit

Press ● (record).

The lamp next to the ● (record) button lights.

NOTES

- Recording pause, if used, will be released in 5 minutes automatically. Picture and sound may be distorted at the point where the recording pause is released.
- You cannot record only sound without pictures on the HDD.

Editing to or from a VCR

You can use the HDD deck as the playback component or as the recording deck.

To use the HDD deck for the playback component:

1 Make connections

Connect the VCR through the L-1 IN/OUT connector on the rear using the 21-pin SCART cable (not supplied).

- If the external VCR is compatible with S-Video signal: Set "L-1 OUTPUT" to "S-VIDEO" (see page 68).

2 Select the HDD deck.

On the remote control

Set the DVD/TV/HDD selector set to the right (HDD), then press ENTER (or LIVE).

On the unit

Press DVD/HDD so that the HDD lamp lights.

3 Select the input mode on the VCR.

- Refer to the instruction manual supplied with the VCR.

4 Start playback on the HDD deck.

Press ► (SELECT).

- You can also use HDD Navigation (see page 29).

5 Start recording on the recording component.

- Refer to the instruction manual supplied with the VCR.

NOTES

- For Y/C signal input/output, be sure to use a 21-pin SCART cable that is compatible with the Y/C signal.
- When you use the HDD deck as the playback component, be sure to set "O.S.D." to "OFF" before starting (see page 67).
- If the VCR is equipped with audio/video (VIDEO/S-VIDEO) input connectors, you can also connect it using those connectors.

Connection only with the SCART cables

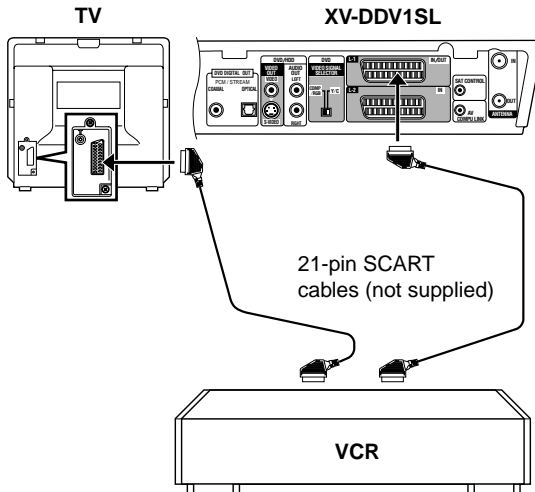

When the VCR is not compatible with S-Video signal, but the TV is compatible:

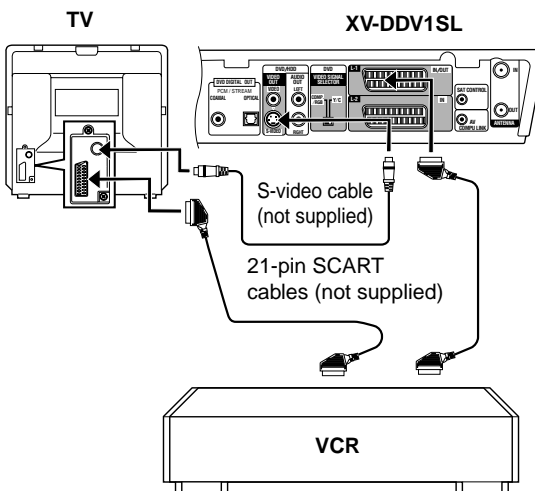

Connection to the L-2 IN connector with the SCART cables

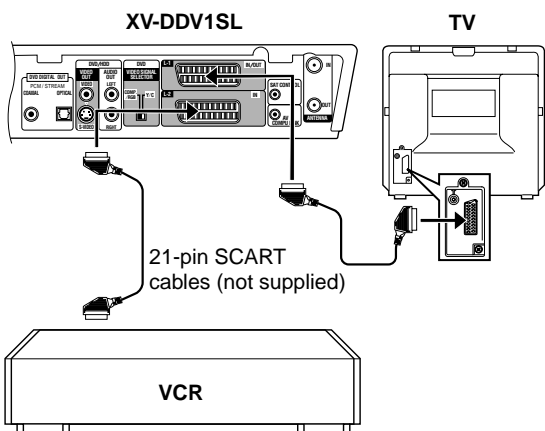

The HDD deck is not compatible with RGB signal input. So do not connect an RGB component to the L-2 IN connector (or do not set the signal output mode of the connected component to RGB signal).

When connecting the VCR to the L-1 IN/OUT connector:

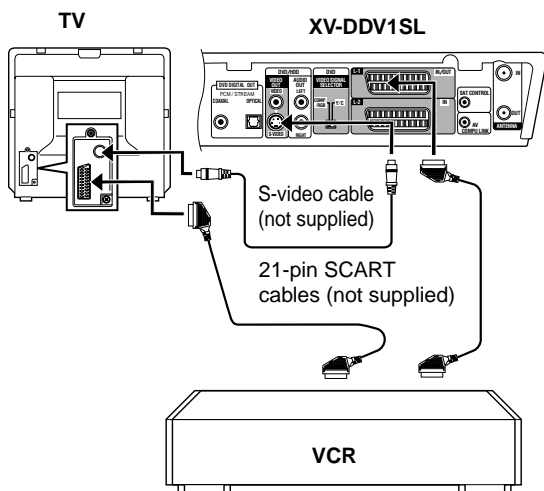

S-Video cable connection is required only when the VCR is not compatible with S-Video, but the TV is compatible.

Precaution before editing onto the HDD

The picture shown on the TV is a few seconds behind the scene currently recorded onto the HDD. Therefore, if you start recording at the desired scene on the TV, you will miss the beginning of the scene by a few seconds. On the other hand, when you stop recording, you will record some extra scenes.

To use the HDD deck for the recording component:

1 Make connections

Connect the VCR through the L-2 IN (or L-1 IN/OUT) connector on the rear using the 21-pin SCART cable (not supplied).

- When using the L-2 IN connector, set "L-2 SELECT" to "A/V" (see page 68).
- If both the external VCR and the TV are compatible with S-Video signal:
Set "L-1 OUTPUT" or "L-2 INPUT" to "S-VIDEO" (see page 68).

2 Select the HDD deck.

On the remote control

Set the DVD/TV/HDD selector set to the right (HDD), then press ENTER (or LIVE).

On the unit

Press DVD/HDD so that the HDD lamp lights.

3 Select the input mode on the HDD deck.

On the remote control

Press AUX (number button "0") and/or HDD/TV PR +/- to select "L-2" for the L-2 IN connection, or "L-1" for the L-1 IN/OUT connection.

On the unit

Press PR +/- to select "L-2" for the L-2 IN connection, or "L-1" for the L-1 IN/OUT connection.

NOTE

When connecting a TV with TV-Link or with equivalent function (see page 15) using the SCART cable, select "OFF" for "DIRECT REC" (see page 67) in order to record S-Video signals through the L-2 IN connector.

4 Start playback on the VCR.

- Refer to the instruction manual supplied with the VCR.

5 Start recording on the HDD deck.

On the remote control

Press and hold REC ●, then press ►.

On the unit

Press ● (record).

The lamp next to the ● (record) button lights.

NOTE

For Y/C signal input/output, be sure to use a 21-pin SCART cable that is compatible with the Y/C signal.

Connecting to a satellite receiver

Simple Connections

This is an example of simple connection if your TV has a 21-pin AV input (SCART) connector.

Connect the satellite receiver to the L-2 IN connector, then connect the TV to the L-1 IN/OUT connector.

NOTES

- Be sure to use a 21-pin SCART cable (not an S-Video cable) for the satellite receiver connection.
- Set "L-2 SELECT" to "A/V" (see page 68).
- You can use Automatic Satellite Recording (see page 46) with this connection.
- To record a programme via the satellite receiver, select "L-2" by pressing **AUX (number button "0")** and/or **HDD/TV PR +/-**. "L-2" appears in the display window.
- For details, refer to the instruction manual of the satellite receiver.

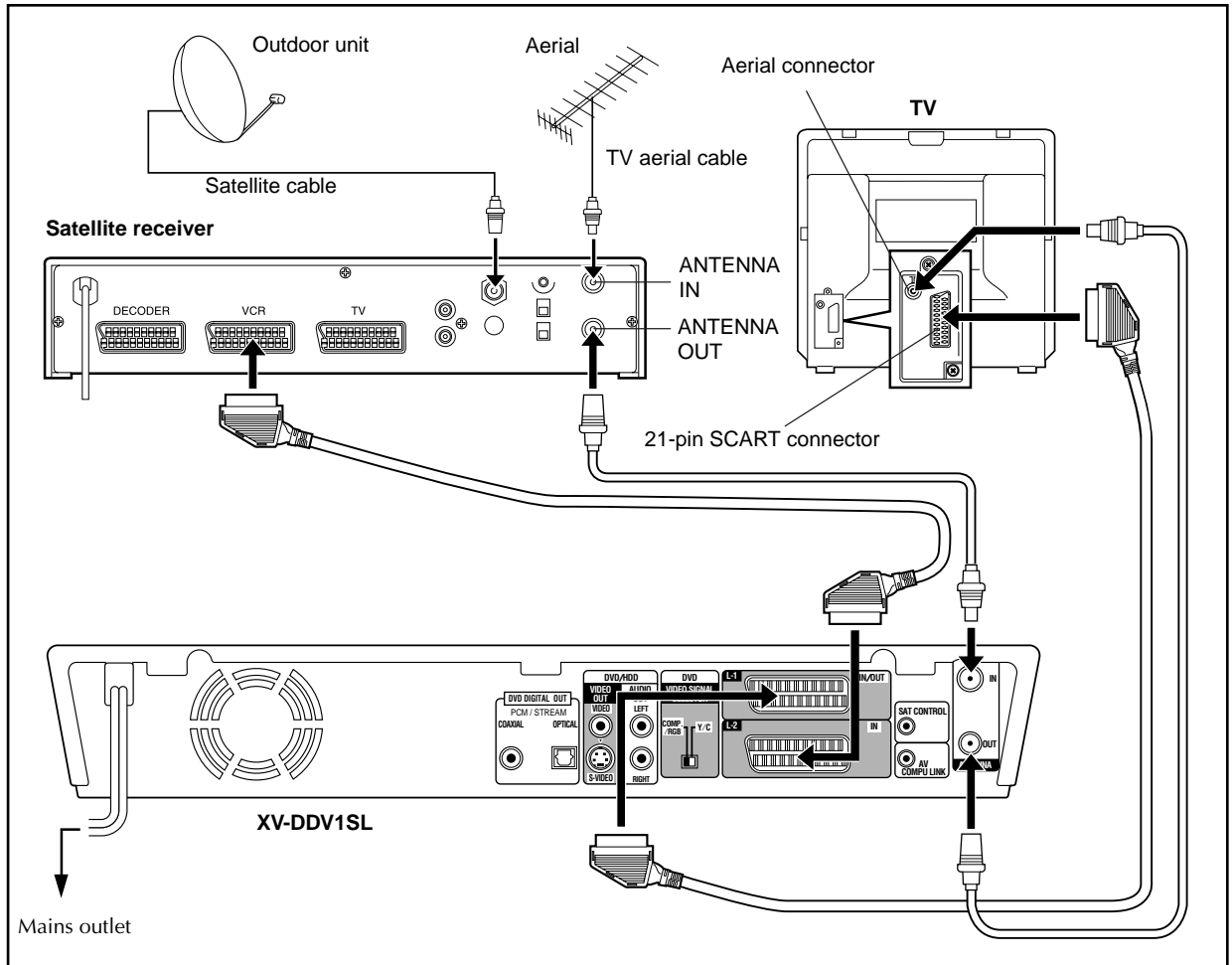

IMPORTANT: When you set "L-2 SELECT" to "SAT" (see page 68)

You can view a satellite broadcast on the TV (with its input (AV) mode correctly selected) without turning on this unit.

To view a satellite programme while this unit is turned on, press **TV/VIDEO** with the **DVD/TV/HDD** selector set to the right (**HDD**) so that the **VIDEO** lamp inside the front panel goes off.

- If you turn on this unit when the satellite receiver is turned off, no picture appears on the TV. If this happens, perform one of the following:
 - To watch a satellite programme, turn on the satellite receiver.
 - To watch TV, select a desired programme position on the TV.
 - To watch a TV programme through the HDD deck, press **TV/VIDEO** so that the **VIDEO** lamp inside the front panel lights.

Connecting to a Stereo System

These instructions enable you to connect the unit to your Hi-fi stereo system (if you have one) and listen to the sound through the Stereo System.

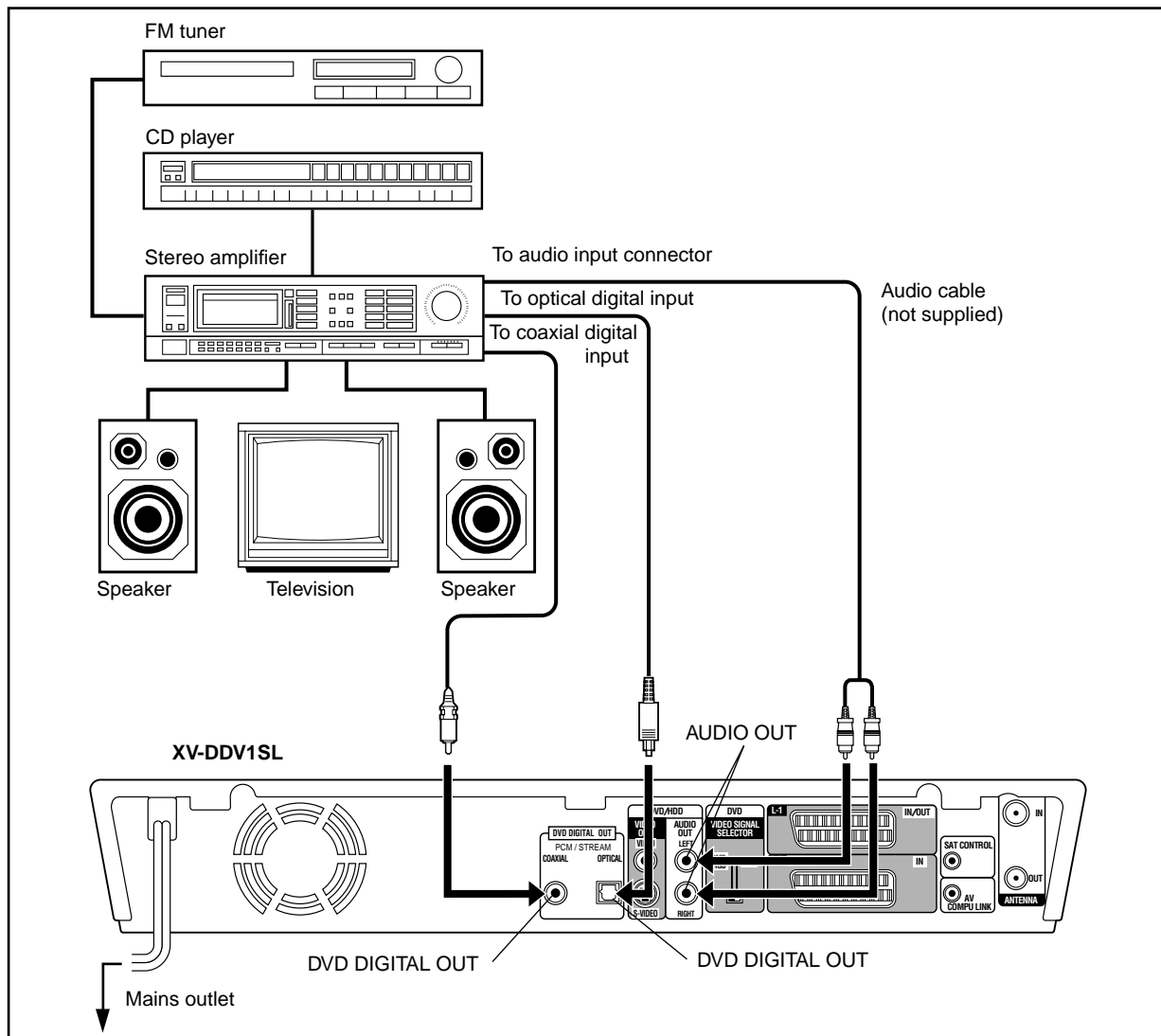

For DVD/HDD playback:

- **When using an audio cable (not supplied):** Connect the AUDIO OUT LEFT and RIGHT connectors on the rear to the audio input connectors, such as AUX IN or LINE IN, on your amplifier.

For DVD playback only:

- **When using an optical digital cable (not supplied):** Connect the DVD DIGITAL OUT OPTICAL connector on the rear to an optical digital input connector on your amplifier.
- **When using an coaxial digital cable (not supplied):** Connect the DVD DIGITAL OUT COAXIAL connection on the rear to a coaxial digital input connector on your amplifier.

NOTES

- You can connect this unit directly to the TV or through the Stereo System using the VIDEO OUT connectors (VIDEO/S-VIDEO).
- When using the DVD DIGITAL OUT connectors, set "DIGITAL AUDIO OUTPUT" correctly to match with the connected component (see page 78).
- You can use the output connectors on the rear to connect a recording device such as an MD recorder.

Troubleshooting

Before requesting service for a problem, use this chart and see if you can repair the trouble yourself.

General

Power does not come on.

⇒ Power plug is not inserted securely. Plug it in securely.

You cannot insert a disc.

⇒ The unit does not accept any operation for about 30 seconds after it is plugged in (during this period, the illumination lamp on the unit flashes).

⇒ Another disc has been already loaded.

The HDD deck does not accept any operations.

⇒ The HDD takes about 20 seconds to make itself ready to work after the unit is turned on.

⇒ The HDD takes about 30 seconds to make itself ready to work after the unit is plugging in. During this period, the illumination lamp on the unit flashes.

"- -: -" appear in the display window.

⇒ There have occurred a power failure. Reset the clock and date again.

Mechanical noise is heard from the HDD deck.

⇒ This occurs since the HDD is rotating at a high speed constantly.

The remote control does not function.

⇒ The DVD/TV/HDD selector is not set correctly. Set it correctly.

⇒ The batteries are discharged. Replace the batteries.

HDD operations

Recording:

You cannot record a programme you want.

⇒ A wrong programme position is selected.

No thumbnail is stored for a programme.

⇒ Modify the thumbnail after recording is over.

TV broadcasts cannot be recorded.

⇒ "L-1," "L-2 (or SAT)," or "F-1" is selected for input mode. Set to the desired programme position on the built-in TV tuner.

Timer recording does not work.

⇒ The clock and/or the timer programmings have been set incorrectly. Reset them.

⇒ There occurs a power failure. Reset the clock and/or timer programmings.

⇒ The current timer recording is interrupted, and will not start recording even after the power is recovered

The VIDEO PLUS+[®] system does not work properly.

⇒ The Guide Program number have been set incorrectly. Reset the Guide Program number correctly.

The picture is not recorded properly from the external component.

⇒ Set "INPUT/OUTPUT" correctly (see page 68).

Pictures recorded through the L-2 IN or INPUT F-1 connector do not have colour.

⇒ Set "DIRECR REC" to "OFF" (see page 68) or record them using Video signals (not using S-Video signals).

Playback:

The playback picture does not appear.

⇒ The correct input (AV) mode is not selected on the TV. Select the correct input (AV) mode.

Noise appears during visual search.

⇒ This is normal.

You cannot start playback.

⇒ You are now at the end of the recording. Press **ON SCREEN** to check where you are.

You cannot use Live Memory.

⇒ You have deactivated the function. Activate it again (see page 67).

DVD operations

General:

You cannot change the playback source from the HDD deck to the DVD player.

⇒ The timer programming or HDD Setup menu screen is shown on the TV. Clear the screen.

"REGION CODE ERROR!" is shown on the TV.

⇒ Region code of the inserted disc does not match the unit. Check the region code of the disc printed on the disc jacket.

Audio language (sound) or subtitle language cannot be changed.

⇒ Disc does not include these languages (or sounds). Check the disc.

⇒ Operations using the AUDIO and SUBTITLE buttons are not accepted during playback. Change the languages using the disc menu screen.

Operations are not possible.

⇒ Microcomputer malfunction due to lightning or static electricity. Turn off the power and unplug the power cord, then connect the power cord again.

⇒ Moisture condensation caused by a sudden change of temperature or humidity. Turn off the power, then turn it on a few hours later.

⇒ The disc does not allow the operation, or an unplayable disc is inserted. Check and replace the disc.

"LOCK" appears in the display window and you cannot eject the disc.

⇒ Disc is locked. You have pressed **▲** while pressing down **DVD/HDD** on the unit while in standby, disc lock is activated. Disc cannot be ejected in this status. To release this status, turn off the unit, then press **▲** while pressing down **DVD/HDD** on the unit.

Picture:**The picture is not displayed properly.**

⇒ Set the DVD VIDEO SIGNAL SELECTOR to the appropriate position (see page 12).

Picture is noisy.

⇒ A VCR is connected in between the unit and the TV. Connect the unit so that the picture signal flows directly to the TV.

⇒ With some discs, the picture may be blurred when "PICTURE SOURCE" is set to "FILM" or "AUTO." Set "PICTURE SOURCE" to "VIDEO (NORMAL)" or "VIDEO (ACTIVE)" (see page 77).

The playback picture through the L-2 IN connector is not displayed properly.

⇒ You have connected an RGB component. Connect a composite video or S-Video component or set the signal output mode of the connected component to composite or S-Video signal (see page 85).

Audio**DVD Video disc playback sound level is lower than TV broadcast sound level.**

⇒ Set the "D.RANGE CONTROL" to "TV MODE" (see page 78).

Sound reproduced are distorted.

⇒ Set the "OUTPUT LEVEL" to "LOW" (see page 78).

MP3 disc:**No sound comes out.**

⇒ MP3 disc is recorded with the "packet writing (UDF format)." It cannot be played.

Files (tracks) are not played in the recorded order.

⇒ This unit plays the files in the alphabetic order. So, the playback order may be different from what you have expected.

JPEG disc:**No picture is played back.**

⇒ Only the baselined-JPEG file can be played back.

The screen turns black.

⇒ Only the baselined-JPEG file can be played back.

On-screen messages

When one of the following messages appear on the TV, follow the instructions shown on the screen to clear the message or to perform the required operations.

MESSAGE	DESCRIPTION
CANNOT DIVIDE DAILY/WEEKLY PROGRAMME	You are trying to divide a daily or weekly recorded programme.
CAN NOT MODIFY INDEX	You cannot modify the thumbnails (index) of a programme while recording is performed in the HDD. Wait until the recording finishes or stop recording to modify the index.
CAN NOT MODIFY LIVE MEMORY TIME, MORE CAPACITY NEEDED DELETE UNWANTED PROGRAMME THEN RETRY	There is not enough memory in the HDD for Live Memory. To increase the free space, delete the unwanted programmes. (See page 36.)
CAPACITY IS FULL, RECORDING STOPPED	The recording stopped due to the shortage of the free space on the HDD.
CAPACITY IS FULL, UNABLE TO RECORD DELETE UNWANTED PROGRAMME FROM HDD	The recording cannot be started due to the shortage of the free space on the HDD.
COPY PROHIBITED, UNABLE TO RECORD ON HDD	You cannot record a copy-protected programme.
DAILY/WEEKLY PROGRAMME SELECTED WHEN NEW RECORDING PERFORMED, CREATED PLAY LIST WILL BE DELETED	You are trying to select a programme recorded by Daily or Weekly Timer for a play list.
DIVISION NOT COMPLETED EXIT?	You are trying to exit from the HDD Navigation editing mode after cancelling division of a programme.

MESSAGE	DESCRIPTION
DO YOU WANT TO DELETE SELECTED INDEX PICTURE?	Appears when you have tried to delete a programme from the HDD. Make sure you really want to delete the programme. (See page 36.)
GUIDE PROGRAM IS NOT SET SET GUIDE PROGRAM THEN RETRY	To use the VIDEO PLUS+ [®] system for timer recording, set Guide Program number in advance. (See page 69.)
PROGRAMME COMPLETED CHECK PROGRAMME LIST TO CONFIRM	Timer programming is completed properly.
NO PROGRAMME TO PLAYBACK	There is no recorded programme in the HDD.
PLUSCODE NO. ERROR CONFIRM PLUSCODE NO. THEN RETRY	An invalid PLUSCODE number is entered.
PLEASE ADJUST CLOCK BEFORE TIMER PROGRAMMING	To set the timer programming, set the built-in clock in advance. (See page 69.)
PROGRAMME FULL DELETE UNWANTED TIMER PROGRAMME	You can store 16 timer programmings. To store a new programming, erase an unnecessary programming. (See page 45.)
PROGRAMME NOT COMPLETED PROGRAMME OVERLAPPED PLEASE CONFIRM AND MODIFY	The timer programming you set is overlapping with another timer programming.
PROGRAMMING NOT COMPLETED EXIT?	Appears when you stop setting timer programming.
REMAINING CAPACITY IS SMALL DELETE UNWANTED PROGRAMME FROM HDD	The remaining capacity of the HDD is short for the current recording.
TITLE MEMORY IS FULL, UNABLE TO RECORD DELETE UNWANTED PROGRAMME FROM HDD	You have already stored 100 programmes in the HDD. The recording cannot be started even though the capacity for the recording is enough.
UNABLE TO GO BACK ANYMORE	You cannot go back beyond the start point of the recording.
UNABLE TO GO FORWARD ANYMORE	You cannot go forward beyond the end point of the recording.
UNABLE TO SET TIMER PROGRAMME DUE TO SHORTAGE OF CAPACITY DELETE UNWANTED PROGRAMME FROM HDD	There is not enough memory in the HDD for recording. To increase the free space, delete the unwanted programmes. (See page 36.)

Country/Area code list for Parental Lock

AD	Andorra	FM	Micronesia (Federated States of)	MC	Monaco	SV	El Salvador
AE	United Arab Emirates	FO	Faroe Islands	MD	Moldova, Republic of	SY	Syrian Arab Republic
AF	Afghanistan	FR	France	MG	Madagascar	SZ	Swaziland
AG	Antigua and Barbuda	FX	France, Metropolitan	MH	Marshall Islands	TC	Turks and Caicos Islands
AI	Anguilla	GA	Gabon	ML	Mali	TD	Chad
AL	Albania	GB	United Kingdom	MM	Myanmar	TF	French Southern Territories
AM	Armenia	GD	Grenada	MN	Mongolia	TG	Togo
AN	Netherlands Antilles	GE	Georgia	MO	Macau	TH	Thailand
AO	Angola	GF	French Guiana	MP	Northern Mariana Islands	TJ	Tajikistan
AQ	Antarctica	GH	Ghana	MQ	Martinique	TK	Tokelau
AR	Argentina	GI	Gibraltar	MR	Mauritania	TM	Turkmenistan
AS	American Samoa	GL	Greenland	MS	Montserrat	TN	Tunisia
AT	Austria	GM	Gambia	MT	Malta	TO	Tonga
AU	Australia	GN	Guinea	MU	Mauritius	TP	East Timor
AW	Aruba	GP	Guadeloupe	MV	Maldives	TR	Turkey
AZ	Azerbaijan	GQ	Equatorial Guinea	MW	Malawi	TT	Trinidad and Tobago
BA	Bosnia and Herzegovina	GR	Greece	MX	Mexico	TV	Tuvalu
BB	Barbados	GS	South Georgia and the South Sandwich	MY	Malaysia	TW	Taiwan
BD	Bangladesh	GT	Guatemala	MZ	Mozambique	TZ	Tanzania, United Republic of
BE	Belgium	GU	Guam	NA	Namibia	UA	Ukraine
BF	Burkina Faso	GW	Guinea-Bissau	NC	New Caledonia	UG	Uganda
BG	Bulgaria	GY	Guyana	NE	Niger	UM	United States Minor Outlying Islands
BH	Bahrain	HK	Hong Kong	NF	Norfolk Island	US	United States
BI	Burundi	HM	Heard Island and McDonald Islands	NG	Nigeria	UY	Uruguay
BJ	Benin	HN	Honduras	NI	Nicaragua	UZ	Uzbekistan
BM	Bermuda	HR	Croatia	NL	Netherlands	VA	Vatican City State (Holy See)
BN	Brunei Darussalam	HT	Haiti	NO	Norway	VC	Saint Vincent and the Grenadines
BO	Bolivia	HU	Hungary	NP	Nepal	VE	Venezuela
BR	Brazil	ID	Indonesia	NR	Nauru	VG	Virgin Islands (British)
BS	Bahamas	IE	Ireland	NU	Niue	VI	Virgin Islands (U.S.)
BT	Bhutan	IL	Israel	NZ	New Zealand	VN	Vietnam
BV	Bouvet Island	IN	India	OM	Oman	VU	Vanuatu
BW	Botswana	IO	British Indian Ocean Territory	PA	Panama	WF	Wallis and Futuna Islands
BY	Belarus	IQ	Iraq	PE	Peru	WS	Samoa
BZ	Belize	IR	Iran (Islamic Republic of)	PF	French Polynesia	YE	Yemen
CA	Canada	IS	Iceland	PG	Papua New Guinea	YT	Mayotte
CC	Cocos (Keeling) Islands	IT	Italy	PH	Philippines	YU	Yugoslavia
CF	Central African Republic	JM	Jamaica	PK	Pakistan	ZA	South Africa
CG	Congo	JO	Jordan	PL	Poland	ZM	Zambia
CH	Switzerland	JP	Japan	PM	Saint Pierre and Miquelon	ZR	Zaire
CI	Côte d'Ivoire	KE	Kenya	PN	Pitcairn	ZW	Zimbabwe
CK	Cook Islands	KG	Kyrgyzstan	PR	Puerto Rico		
CL	Chile	KH	Cambodia	PT	Portugal		
CM	Cameroon	KI	Kiribati	PW	Palau		
CN	China	KM	Comoros	PY	Paraguay		
CO	Colombia	KN	Saint Kitts and Nevis	QA	Qatar		
CR	Costa Rica	KP	Korea, Democratic People's Republic of	RE	Réunion		
CU	Cuba	KR	Korea, Republic of	RO	Romania		
CV	Cape Verde	KW	Kuwait	RU	Russian Federation		
CX	Christmas Island	KY	Cayman Islands	RW	Rwanda		
CY	Cyprus	KZ	Kazakhstan	SA	Saudi Arabia		
CZ	Czech Republic	LA	Lao People's Democratic Republic	SB	Solomon Islands		
DE	Germany	LB	Lebanon	SC	Seychelles		
DJ	Djibouti	LC	Saint Lucia	SD	Sudan		
DK	Denmark	LI	Liechtenstein	SE	Sweden		
DM	Dominica	LK	Sri Lanka	SG	Singapore		
DO	Dominican Republic	LR	Liberia	SH	Saint Helena		
DZ	Algeria	LS	Lesotho	SI	Slovenia		
EC	Ecuador	LT	Lithuania	SJ	Svalbard and Jan Mayen		
EE	Estonia	LU	Luxembourg	SK	Slovakia		
EG	Egypt	LV	Latvia	SL	Sierra Leone		
EH	Western Sahara	LY	Libyan Arab Jamahiriya	SM	San Marino		
ER	Eritrea	MA	Morocco	SN	Senegal		
ES	Spain			SO	Somalia		
ET	Ethiopia			SR	Suriname		
FI	Finland			ST	Sao Tome and Principe		
FJ	Fiji						
FK	Falkland Islands						

Table of languages and their abbreviations

AA	Afar	FA	Persian	KM	Cambodian	OM	(Afan) Oromo	SU	Sundanese
AB	Abkhazian	FI	Finnish	KN	Kannada	OR	Oriya	SV	Swedish
AF	Afrikaans	FJ	Fiji	KO	Korean (KOR)	PA	Panjabi	SW	Swahili
AM	Ameharic	FO	Faroese	KS	Kashmiri	PL	Polish	TA	Tamil
AR	Arabic	FY	Frisian	KU	Kurdish	PS	Pashto, Pushto	TE	Telugu
AS	Assamese	GA	Irish	KY	Kirghiz	PT	Portuguese	TG	Tajik
AY	Aymara	GD	Scots Gaelic	LA	Latin	QU	Quechua	TH	Thai
AZ	Azerbaijani	GL	Galician	LN	Lingala	RM	Rhaeto-Romance	TI	Tigrinya
BA	Bashkir	GN	Guarani	LO	Laothian	RN	Kirundi	TK	Turkmen
BE	Byelorussian	GU	Gujarati	LT	Lithuanian	RO	Rumanian	TL	Tagalog
BG	Bulgarian	HA	Hausa	LV	Latvian, Lettish	RU	Russian	TN	Setswana
BH	Bihari	HI	Hindi	MG	Malagasy	RW	Kinyarwanda	TO	Tongan
BI	Bislama	HR	Croatian	MI	Maori	SA	Sanskrit	TR	Turkish
BN	Bengali, Bangla	HU	Hungarian	MK	Macedonian	SD	Sindhi	TS	Tsonga
BO	Tibetan	HY	Armenian	ML	Malayalam	SG	Sangho	TT	Tatar
BR	Breton	IA	Interlingua	MN	Mongolian	SH	Serbo-Croatian	TW	Twi
CA	Catalan	IE	Interlingue	MO	Moldavian	SI	Singhalese	UK	Ukrainian
CO	Corsican	IK	Inupiak	MR	Marathi	SK	Slovak	UR	Urdu
CS	Czech	IN	Indonesian	MS	Malay (MAY)	SL	Slovenian	UZ	Uzbek
CY	Welsh	IS	Icelandic	MT	Maltese	SM	Samoan	VI	Vietnamese
DA	Danish	IW	Hebrew	MY	Burmese	SN	Shona	VO	Volapuk
DZ	Bhutani	JL	Yiddish	NA	Nauru	SO	Somali	WO	Wolof
EL	Greek	JW	Javanese	NE	Nepali	SQ	Albanian	XH	Xhosa
EO	Esperanto	KA	Georgian	NL	Dutch	SR	Serbian	YO	Yoruba
ET	Estonian	KK	Kazakh	NO	Norwegian	SS	Siswati	ZU	Zulu
EU	Basque	KL	Greenlandic	OC	Occitan	ST	Sesotho		

Digital output signal chart

Disc type	Output		
	PCM ONLY	DOLBY DIGITAL/PCM	STREAM/PCM
DVD with 48 kHz, 16/20/24 bit linear PCM	48 kHz, 16 bit, stereo linear PCM		
DVD with 96 kHz, 16/20/24 bit linear PCM	48 kHz, 16 bit, stereo linear PCM (Down sampling)		
DVD with DTS	48 kHz, 16 bit, stereo linear PCM		DTS bitstream
DVD with Dolby Digital	48 kHz, 16 bit, stereo linear PCM	Dolby Digital bitstream	
DVD with MPEG Multichannel	48 kHz, 16 bit, stereo linear PCM		MPEG bitstream
SVCD/Video CD/Audio CD	44.1 kHz, 16 bit, stereo linear PCM		
Audio CD with DTS	44.1 kHz, 16 bit, stereo linear PCM		DTS bitstream
CD-R/RW with MP3	Linear PCM		

NOTE

With some DVD Video discs that are not fully copy-protected, a 20 or 24 bit digital signal may be output.

Glossary

Aspect ratio

A ratio which defines the shape of the rectangular picture on a TV. It is the width of the picture relative to the height. A conventional TV picture is 4:3 in aspect ratio.

Bitstream

The digital format of multichannel audio data (e.g., 5.1-channel) before it is decoded into its various channels.

Chapter/title

Chapter is the smallest division and title is the largest division on DVD Video. A chapter is a division of a title and similar to a track for VCD or CD.

Dolby Digital (AC3)

A six-channel system consisting of left, centre, right, left rear, right rear and LFE (Low-Frequency Effect channel, for use with a subwoofer) channels. All processing is done in the digital domain. Not all Dolby Digital discs contain six (5.1) channels.

Dolby Surround/Dolby Pro Logic

Dolby Surround records four channels of front and rear audio in two channels in a way that allows a decoder to recover the original four channels for playback. Because the audio is recorded in two channels, it can be played back naturally by a two-channel stereo system.

Dolby Pro Logic introduces directional circuits in decoder-side processing (increasing the level of specific channels and lowering the level of silent channels) for greater spatial perspective, and adds a centre speaker used primarily for dialogue. The result is enhanced channel separation.

DTS

A digital surround audio encoding format configured with six (5.1) channels, similar to Dolby Digital.

DTS stands for Digital Theatre Systems.

Not all DTS discs contain six (5.1) channels of information.

Dynamic range

The difference between the loudest and softest sounds.

JPEG

A popular file format for still image compression and storage.

JPEG stands for Joint Photographic Experts Group.

There are three sub-types of the JPEG format as follows.

- Baseline JPEG: used for digital cameras, the web, etc.
- Progressive JPEG: used for the web
- Lossless JPEG: an old type, rarely used now

Linear PCM

PCM stands for "pulse code modulation." Linear PCM is the usual method for digitally encoding audio without compression, and is used for the audio tracks on DVD Video discs, CDs, etc.

MP3

MP3 is an audio data compression format, which stands for MPEG-1 Audio Layer 3. Using MP3, you can achieve a data reduction of about 1:10 compared to a conventional CD.

MPEG

A family of Standards for compressing visual signals. "MPEG" standards include MPEG-1, MPEG-2 and MPEG-4. Video CD is based on MPEG-1, while DVD is based on MPEG-2. MPEG stands for Moving Picture Experts Group.

- This is also used for compressing audio signals (ex. MP3).

MPEG Multichannel

This feature expands the 5.1 channel audio format recorded in the disc to a 7.1 channel format. The further expansion of the 5.1 channel audio makes it easy for you to reproduce the movie theatre experience in your own home.

NICAM

Broadcast providing stereo, FM sound, or bilingual programmes. The TV tuner built in this unit can receive these NICAM signals.

NTSC (National television system committee)

A black and white and colour television system format used in the U.S.A., Canada, Mexico and Japan.

PAL (Phase Alternation by Line)

A colour television system format used extensively in Western Europe.

PBC

PBC stands for "Playback control" and is a method of controlling disc play for Video CDs (VCD). You are able to interact with the disc through menus.

RGB

An abbreviation for Red, Green, and Blue. Colour monitors and colour television sets display different hues by mixing these three colours.

Track

The smallest division on SVCD, Video CD and Audio CD discs.

Specifications

HDD Deck—Video/Audio

Video format:	MPEG2 (VBR)
Audio format:	MPEG1 Layer2
Maximum recording time (approx.):	
(SP):	20 hours
(LP):	28 hours
(EP):	56 hours
(SEP):	80 hours

DVD player—Audio

Total harmonic distortion:	Less than 0.006%
Dynamic range:	
16 bits:	98 dB
20 bits:	100 dB
24 bits:	100 dB

Frequency range

CD (fs=44.1 kHz):	2 Hz to 20,000z
DVD (fs=48 kHz):	2 Hz to 22,000z
DVD (fs=96 kHz):	2 Hz to 44,000z

Output level:

DVD/HDD AUDIO OUT:	2 Vrms (10 k Ω)
DVD DIGITAL OUT:	
COAXIAL:	0.5Vp-p (75 Ω termination)
OPTICAL:	-21dBm to -15dBm(Peak)

DVD player—Video

Horizontal resolution:	500 lines
Output level:	
RGB:	0 – 700 mV (75 Ω)
S-video (Y):	1.0 Vp-p (75 Ω)
(C):	300 mV (75 Ω)
Composite video:	1.0 Vp-p (75 Ω)

Tuner/Timer

TV channel storage capacity:	99 positions (+AUX position)
Tuning system:	Frequency synthesized tuner
Channel coverage:	VHF: 44.5 MHz – 143 MHz/ 143 MHz – 470 MHz
	UHF: 470 MHz – 862 MHz
Memory backup time:	Approx. 10 min.

General

Power requirement:	AC 230 V \sim , 50 Hz
Power consumption:	
Power on:	45 W
Power off:	15 W
Operating position :	Horizontal only
Dimensions (WxHxD):	435 mm x 68 mm x 346 mm
Weight:	4.8 kg

Accessories

RF cable:	x 1
Audio/video cable:	x 1
Satellite Controller:	x 1
Remote control unit:	x 1
Battery—R6P(SUM-3)/AA(15F):	x 2

Specifications and appearance are subject to change without prior notice.

Index

Numerics & Symbols

3D PHONIC

- ACTION 57
- DRAMA 57
- THEATER 57

x1.5 Quick Playback with sound 49

A

ACTION 57

AUDIO

- ANALOG DOWN MIX 78
- D. RANGE CONTROL 78
- DIGITAL AUDIO OUTPUT 78

• OUTPUT LEVEL 78

Audio language 56, 76

AUDIO REC 67

Auto Channel Setup 70

Auto Setup 13

Automatic Satellite Recording 46

B

Basic Playback 25

Basic Recording 23

BRIGHTNESS 58

C

CATEGORY 32

Changing the DVD settings 75

Confirming on-screen information 28, 48

Connections

- Basic 11
- Composite video 12, 84 – 86
- SCART connector 11
- Satellite receiver 17, 86
- Stereo System 87
- S-video 12, 83 – 85
- TV-linked Setup 14

CONTRAST 58

D

D. RANGE CONTROL 78

Daily Timer 43

DIRECT REC 67

Disc menu 51

DRAMA 57

DVD Initial Setup 20

DVD playback

- Frame-by-Frame playback 50
- Pause 48
- Program Play 53
- Quick & Short Review 50
- Random Play 54, 63, 65
- Repeat Play 54
- Slow Motion 50
- Time Search 52
- Various speed playback 49

E

Editing

- from a camcorder 83

- to or from a VCR 84

Express Timer programming 42

F

F-1 INPUT 68

Frame-by-Frame Playback 27, 50

FUNCTION SET UP 66

G

GAMMA 58

H

HDD Navigation

- CATEGORY 32
 - Editing 34
 - Playing 29
 - TITLE 33
- HDD SET UP 66

I

INITIAL SET UP 66

INPUT/OUTPUT

- F-1 INPUT 68
 - L-1 INPUT 68
 - L-1 OUTPUT 68
 - L-2 INPUT 68
 - L-2 SELECT 68
- Instant Timer Recording (ITR) 24

J

JPEG disc 63

Jump Search 27

JUMP TIME 67

JVC Customer Service 15

L

L-1 INPUT 68

L-1 OUTPUT 68

L-2 INPUT 68

L-2 SELECT 68

LANGUAGE

- AUDIO LANGUAGE 76
 - MENU LANGUAGE 76
 - SUBTITLE 76
- LIVE MEMORY 67

Live Memory

- Playback (Pause) 21
- Playback (Replay) 22
- Recording 22

M

Manual Channel Setup 71

Menu bar operations 59

MENU LANGUAGE 76

MONITOR TYPE 77

MP3 disc 61

MP3/JPEG 77

Multi-angle 56

N

NICAM broadcasts 22

O

O.S.D. 67

ON SCREEN GUIDE 79

Once Timer 43

One Touch Replay 26, 50

On-screen guide icons 48

OTHERS

- AV COMPULINK MODE 79
- ON SCREEN GUIDE 79
- PARENTAL LOCK 79
- RESUME 79

OUTPUT LEVEL 78

P

Parts identification 6

Pause

- Playback 25
- Recording 83

PICTURE

- MONITOR TYPE 77
- MP3/JPEG 77
- PICTURE SOURCE 77
- SCREEN SAVER 77
- PICTURE SOURCE 77

Play list 30, 37

Playback Control 48

PlusCode number 40

Program Play 53

Programme Delivery Control Recording 44

Q

Quick Skip 26

R

Random Play 54

Recording speed 24

Remaining time 24, 60

Repeat Play 27, 54, 63, 65

RESUME 79

Resume playback 49

S

SATURATION 58

Screen

- DVD PLAYER SET UP 20
- JPEG CONTROL 64
- MP3 CONTROL 61
- NAVIGATION 29
- Opening 16
- PARENTAL LOCK 80
- PLAY LIST 30
- PLAY LIST/CREATE 38
- PROGRAMME LIST 45
- REC LIST 30
- REC LIST/DELETE 36
- REC LIST/DIVIDE 37
- REC LIST/MODIFY 35
- SCREEN SAVER 77

Screen saver 48

Setup

- Auto Channel 70
- Auto Setup 13
- clock time 69
- DVD Initial 20
- Easy & simple 13
- Guide Program number 69

- Manual Channel 71
 - Remote control code 82
 - Satellite controller 17
 - T-V Linked Setup 14
- SHARPNESS 58

Slide show 65

Slow Motion 27, 50

Special Effect Playback

- Frame-by-Frame Playback 27

- Jump Search 27

- One Touch Replay 26

- Quick Skip 26

- Repeat Playback 27

- Slow Motion 27

- Still Picture 27

- Variable Speed Search 26

Status bar 59

Still Picture 27, 48

Subtitle 56, 76

T

THEATER 57

Time Search 52

Timer programming

- Express 42
- VIDEO Plus+® 40

TINT 58

TITLE 33

TV station and ID list 73

TV station channel number guide 74

TV-Linked Setup 14

T-V LINK 15

V

Variable Speed Search 26

Various speed playback 49

- Frame-by-Frame Playback 50

- One Touch Replay 50

- Slow Motion 50

Variable Speed Search 26

Video Fine Processor 58

W

Watching TV Programmes 21

Weekly Timer 43

Y

Y DELAY 58

Z

Zoom 58, 65

SAFETY INSTRUCTIONS

“SOME DOS AND DON'TS ON THE SAFE USE OF EQUIPMENT”

This equipment has been designed and manufactured to meet international safety standards but, like any electrical equipment, care must be taken if you are to obtain the best results and safety is to be assured.

Do read the operating instructions before you attempt to use the equipment.

Do ensure that all electrical connections (including the mains plug, extension leads and interconnections between pieces of equipment) are properly made and in accordance with the manufacturer's instructions. Switch off and withdraw the mains plug when making or changing connections.

Do consult your dealer if you are ever in doubt about the installation, operation or safety of your equipment.

Do be careful with glass panels or doors on equipment.

DON'T continue to operate the equipment if you are in any doubt about it working normally, or if it is damaged in any way—switch off, withdraw the mains plug and consult your dealer.

DON'T remove any fixed cover as this may expose dangerous voltages.

DON'T leave equipment switched on when it is unattended unless it is specifically stated that it is designed for unattended operation or has a standby mode.

Switch off using the switch on the equipment and make sure that your family know how to do this.

Special arrangements may need to be made for infirm or handicapped people.

DON'T use equipment such as personal stereos or radios so that you are distracted from the requirements of traffic safety. It is illegal to watch television whilst driving.

DON'T listen to headphones at high volume as such use can permanently damage your hearing.

DON'T obstruct the ventilation of the equipment, for example with curtains or soft furnishings. Overheating will cause damage and shorten the life of the equipment.

DON'T use makeshift stands and NEVER fix legs with wood screws—to ensure complete safety always fit the manufacturer's approved stand or legs with the fixings provided according to the instructions.

DON'T allow electrical equipment to be exposed to rain or moisture.

ABOVE ALL

—NEVER let anyone, especially children, push anything into holes, slots or any other opening in the case—this could result in a fatal electrical shock;

—NEVER guess or take chances with electrical equipment of any kind—it is better to be safe than sorry!

JVC
VICTOR COMPANY OF JAPAN, LIMITED